

JAGUAR XE



THE ART OF PERFORMANCE





BY APPOINTMENT TO
HM THE QUEEN
MANUFACTURERS OF
MOTOR VEHICLES
JAGUAR LAND ROVER LIMITED
COVENTRY



BY APPOINTMENT TO
HRH THE DUKE OF EDINBURGH
MANUFACTURERS OF
MOTOR VEHICLES
JAGUAR LAND ROVER LIMITED
COVENTRY



BY APPOINTMENT TO
HRH THE PRINCE OF WALES
MANUFACTURERS OF
MOTOR VEHICLES
JAGUAR LAND ROVER LIMITED
COVENTRY



JAGUAR

THE ART OF PERFORMANCE

Every day we push performance to its limit. Our performance. Our cars' performance.
We innovate, we engineer, we design. We master rules and then break them.
Only to push further. Past the limits of convention. This is when performance becomes art.

Jaguar. The Art of Performance.



CONTENTS

INTRODUCTION

Concept of XE	07
XE - The Facts	08

DESIGN

Exterior Principles	10
Exterior Detail	12
Interior	17

PERFORMANCE

Engines	18
Transmissions	22
Advanced Aerodynamics	24
Lightweight Aluminium Architecture	27
Chassis and Suspension	28

DRIVING TECHNOLOGY

Advanced Driving Dynamics	31
All Surface Progress Control	32
Advanced Drivetrain Technology	35
Torque Vectoring	37
Stability and Control	38
Head-up display	41

INFOTAINMENT

InControl Technologies	42
InControl Touch	45
InControl Connect	45
InControl Touch Pro	47
InControl Connect Pro	47
Audio	48

SAFETY AND EFFICIENCY

Advanced Driver Assistance	50
Efficient Technologies	52

PERSONALISATION

XE - Your Choice	54
Choose your Engine	56
Choose your Model	58
Choose your Options	60
Choose your Colour	66
Choose your Wheels	68
Choose your Interior	70
Choose your Accessories	88
Technical Specifications	92
Dimensions	94

JAGUAR WORLD

Jaguar Experience	96
The World of Jaguar	98
Glossary and Legal Information	100



Scan to find out more about the Jaguar XE.





INTRODUCTION

THE CONCEPT OF XE

The most advanced, efficient and refined sports saloon car that Jaguar has ever produced. Instantly recognisable as a Jaguar, it feels like a Jaguar, it drives like a Jaguar - XE is a Jaguar to its core.

XE is the foundation of the Jaguar saloon car family. A distillation of the design, luxury and technology found in XF and XJ. Inspired by our F-TYPE sports car, with its assertive looks and agile drive.

Now the XE comes with the option of All Wheel Drive with Intelligent Driveline Dynamics which gives it greater capability in challenging road conditions. You can also upgrade to the very latest in-car infotainment with our powerful new InControl Touch Pro system.

XE is an exceptional blend of technology, design, and driving dynamics that rewrites all the rules. XE is a wake up call for every other car in its class.

VEHICLE SHOWN: XE S IN ITALIAN RACING RED WITH OPTIONAL FEATURES FITTED (MARKET DEPENDENT)

XE - THE FACTS

XE brings together the latest Jaguar innovation, technology and design.

EFFICIENCY AND PERFORMANCE

XE is capable of achieving a drag coefficient as low as Cd 0.26, one of the lowest in its class. It cuts through the air to improve efficiency and refinement. From the outright exhilaration of a supercharged V6 capable of up to 250km/h to the frugality of CO₂ emissions as low as 99g/km with our turbocharged 4-cylinder diesel, there are a range of engines to suit every driving style.

JAGUAR CARE*

XE is now offered with a new unlimited mileage, three year warranty and three years' servicing programme at no additional cost. We call this programme Jaguar Care. It makes XE's overall cost of ownership one of the lowest in its class.



*Selected European Markets Only.

VEHICLE SHOWN: XE S IN ITALIAN RACING RED WITH OPTIONAL FEATURES FITTED (MARKET DEPENDENT)

CAPABILITY

XE offers Jaguar's unique All Wheel Drive with Intelligent Driveline Dynamics and Adaptive Surface Response. Available with selected engines, this maximises the legendary Jaguar handling, agility and ride, and gives added confidence in all conditions.

ADDED INTELLIGENCE

Innovative technologies make every drive easier and safer. XE offers Adaptive Bi-function Xenon Headlights, Traffic Sign Recognition and Adaptive Speed Limiter, Lane Keep Assist with Driver Condition Monitor, Autonomous Emergency Braking, Adaptive Cruise Control with Queue Assist, and Advanced Park Assist.

ALWAYS CONNECTED

InControl Touch Pro is now available in XE. This next generation infotainment system offers a range of new features to enhance every journey. These include Digital Television, Meridian Digital Sound Systems and Connected Navigation.



LIGHTWEIGHT ALUMINIUM ARCHITECTURE

XE's lightweight architecture creates an incredibly strong body - underpinning power with responsive handling, and refinement with beautiful design.



DESIGN EXTERIOR PRINCIPLES



DYNAMIC PROPORTIONS

MUSCULAR LOOKS

"It's about paring it down to the bare essentials. Good designers have always said less is more."
Ian Callum, Jaguar Design Director.

XE stands out from the competition with the clean surfaces and dynamic looks that form the core of Jaguar design. This is because XE's Lightweight Aluminium Architecture gave its designers the freedom to work alongside engineers to optimise the car's proportions – XE is unmistakably a Jaguar. The long, distinctly defined bonnet is aerodynamically sculpted to channel air over and around the body for greater efficiency. Along with the rising waistline and 'cab rearward' design, it ensures that XE shares the athleticism of the other cars in the Jaguar range. XE is crouching, ready to pounce.

VEHICLE SHOWN RIGHT: XE S IN ITALIAN RACING RED
WITH OPTIONAL FEATURES FITTED (MARKET DEPENDENT)



EXTERIOR DETAIL

INNOVATIVE DESIGN

One glance at XE and you know that it could only be a Jaguar. From the headlights featuring Jaguar signature 'J' blade Daytime Running Lights*, the powerfully sculpted bonnet, and the chrome side vents, stamped with the Jaguar name, all the way to those distinctive rear haunches. Only Jaguar, as a world leader in aluminium car construction, has the technology and expertise to create sharper creases from deeper, more innovatively formed pressings. The body side curvature of XE is aerodynamically honed to sweep air seamlessly rearwards to the tail. The deliberately cropped rear has a short overhang, underscoring the car's performance credentials and enhancing airflow. It culminates with those iconic tail lights that are inspired by the F-TYPE sports car.

*Available with Bi-function Xenon and Adaptive Bi-function Xenon headlights only.
VEHICLE SHOWN: XE R-SPORT IN BLUEFIRE WITH OPTIONAL FEATURES FITTED
(MARKET DEPENDENT)





XDY 446

JAGUAR

XE

2014









INTERIOR



COCKPIT FEEL

EXTENSIVE CHOICE

Connect with XE the moment you slide into the form-hugging seats - you sit low in a Jaguar. Next to you the raised centre console adds to the cockpit feel.

Pulsing with a heartbeat, the car creates an emotional connection between driver and machine. Its 72 per minute double beat is the same as a jaguar cat at rest. Press the Start button and XE awakes, the needles sweep, the engine growls. On cars with automatic transmissions, the JaguarDrive Selector rises to greet your hand.

The outer air vents are unique in the way that they extend the fascia to nestle in the door casings and give the feeling of width and space. Throughout XE the natural forms of the interior architecture lend themselves to the extensive choice of contemporary or traditional materials and finishes. XE is an inspired place for driver and passengers to be.

INTERIOR SHOWN LEFT AND PREVIOUS PAGE: XE S FEATURING RED LEATHER SPORT SEATS WITH JET SUEDECLOTH INSERTS WITH OPTIONAL FEATURES FITTED (MARKET DEPENDENT)

PERFORMANCE ENGINES



INGENIUM ENGINES

STOP/START TECHNOLOGY*

XE's power is delivered by a range of highly advanced petrol and diesel engines, including two 4-cylinder turbocharged diesel engines from our Ingenium engine family. Whether you choose our latest hi-tech diesel engines or you prefer petrol, each one offers performance, refinement and economy to suit every driving style. XE's engines are equipped with Stop/Start technology* and smart regenerative charging - harvesting kinetic energy from braking to charge the battery - for maximum economy, especially during urban driving. For information on fuel consumption, CO₂ emissions and performance figures for XE engines, please refer to pages 92 to 93.



INGENIUM DIESEL ENGINES FROM

99g/km CO₂

XE is offered with two diesel engines from our Ingenium range: the 2.0 litre 4-cylinder turbocharged diesel (163PS) and the 2.0 litre 4-cylinder turbocharged diesel (180PS) producing 380Nm and 430Nm of torque respectively. Ingenium is Jaguar Land Rover's new breed of engine designed for effortless performance, refinement and efficiency. With advanced technology and all-aluminium construction, Ingenium delivers impressive fuel consumption and CO₂ emissions. Up to 20kg lighter than equivalent previous generation engines, Ingenium is intrinsically more efficient. And intelligent too - computer controlled, adaptive engine cooling only engages as required. The latest generation variable geometry turbocharger maximises peak power for low speed torque and responsiveness that is uniform, progressive and avoids lag. Internal friction - the enemy of performance and efficiency - is up to 17 percent lower in the Ingenium range than previous generation engines.

*Market dependent.



PETROL ENGINES UP TO

0-100km/h in 6.8 seconds

XE's 4-cylinder petrol engines offer power and responsiveness throughout the rev range, while improving efficiency. The 2.0 litre 4-cylinder turbocharged petrol (200PS) and the 2.0 litre 4-cylinder turbocharged petrol (240PS) engines both achieve 6-cylinder engine levels of performance and refinement from a more compact and economical structure.

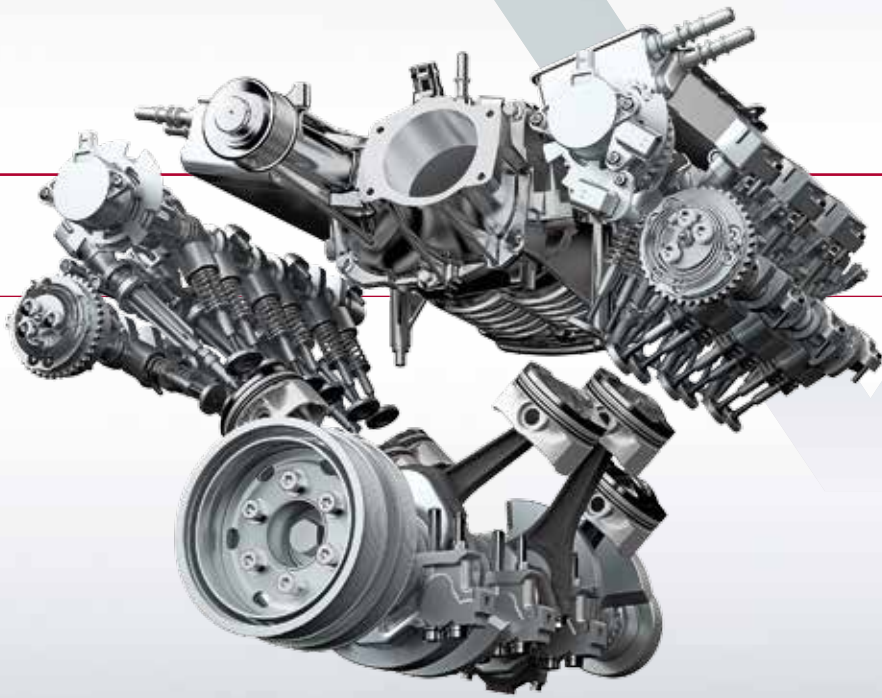

SUPERCHARGED PETROL ENGINE

0-100km/h in 5.1 seconds

The 3.0 litre V6 supercharged petrol engine has been adapted for the specific requirements of XE. A Roots-type twin vortex supercharger is mounted in the 'V' between the two rows of cylinders for compact dimensions. Supercharging provides linear delivery of power and maximises responsiveness. This results in performance matching much larger engines, while optimising economy and reducing emissions. The engine also features dual independent variable cam timing to vary inlet and exhaust valve operation, working alongside lightweight pistons with ultra-low friction piston rings, for increased performance and efficiency. For added refinement there is a twin, contra-rotating balancer shaft system. The V6 supercharged petrol engine is available with Rear Wheel Drive Automatic transmission only.

VEHICLE SHOWN: XE S IN AMMONITE GREY WITH OPTIONAL FEATURES FITTED
(MARKET DEPENDENT)



AUTOMATIC TRANSMISSION

EIGHT-SPEED AUTOMATIC TRANSMISSION

XE's automatic transmission is highly responsive, smooth and efficient. It delivers rapid shifting for effortless acceleration and overtaking. The intelligent, adaptive system subtly changes the way the throttle delivers power, as well as gearshift patterns, to suit each particular driving circumstance. The JaguarDrive Control offers even quicker shifts and sportier kick-down in Dynamic Mode, and earlier up-shifts in Eco Mode. With the automatic transmission the driver can opt to manually control gearshifts, via steering wheel paddles, at the touch of a finger.



MANUAL TRANSMISSION

SIX-SPEED MANUAL TRANSMISSION

Choose the six-speed manual gearbox* for even greater driver involvement. This lightweight, highly advanced unit contributes to XE's outstanding efficiency. Its aluminium alloy casing, hollow shafts and pocketed gears save every gram of weight possible. We use an advanced direct lubrication system to reduce friction and drag for greater efficiency and further weight saving. Specifically designed for the performance requirements of sports cars - it delivers slick, short changes and superb levels of comfort.

*Manual transmission is available on 2.0 litre 4-cylinder 163PS (E-Performance) and 2.0 litre 4-cylinder 180PS Rear Wheel Drive Turbocharged Ingenium engines. Market dependent.



ADVANCED AERODYNAMICS



ADVANCED AERODYNAMICS

HIGHLY EFFICIENT

XE's form has been rigorously optimised for aerodynamic efficiency and stability. With a drag co-efficient as low as Cd 0.26, XE cuts through the air - reducing fuel consumption and lowering emissions. Every element exploits the exterior's maximum aerodynamic potential while preserving XE's stunning proportions. Vertical apertures in the front bumper's outer edges channel air through vents in the wheel arches and out over the front wheels. Even the race car-inspired underbody protection and diffuser is designed to make XE as efficient, economical and refined as possible.

VEHICLE SHOWN: XE R-SPORT IN BLUEFIRE WITH OPTIONAL FEATURES FITTED (MARKET DEPENDENT)





LIGHTWEIGHT ALUMINIUM ARCHITECTURE



PERFECT BALANCE

STRONG AND LIGHTWEIGHT

Jaguar has been at the forefront of aluminium car construction for more than a decade and continues to push the boundaries of this technology. XE is based on our Lightweight Aluminium Architecture, which uses expertise derived from the aerospace industry to deliver premium vehicle characteristics in performance and refinement. This immensely strong bodyshell uses a high strength 6000 series aluminium alloy. Saving weight without compromising durability, it provides very high torsional stiffness, supporting precise handling. It helps achieve optimum weight distribution approaching 50:50. The lightweight structure not only reduces fuel consumption and CO₂ emissions, it means that the XE range is able to encompass everything from as low as 99g/km to a maximum speed of up to 250km/h.

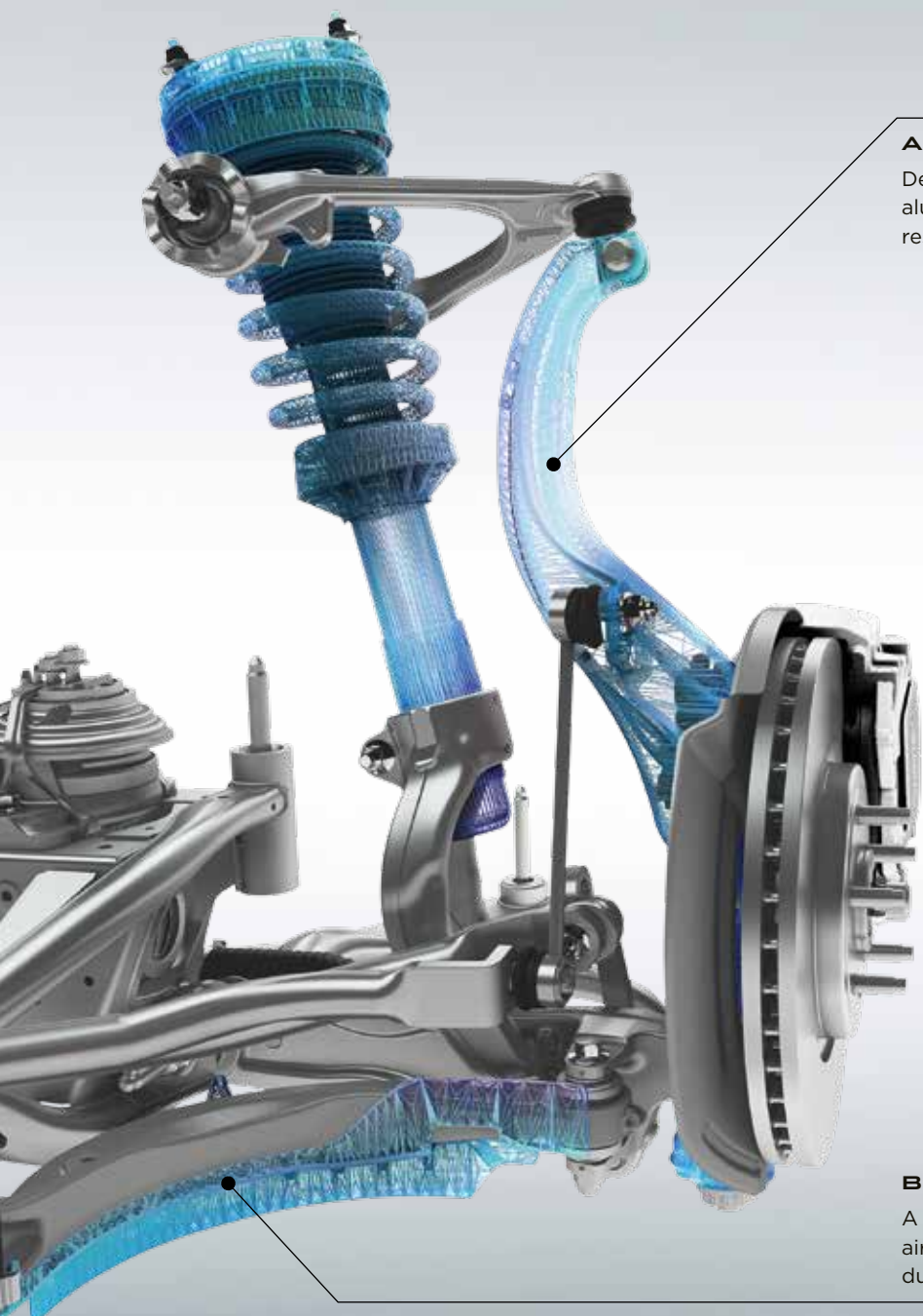

ALUMINIUM FRONT KNUCKLE

Designed to optimum stiffness and strength, the lightweight aluminium front knuckle helps improve XE's agility, responsiveness and refinement for sports car-like control.

CHASSIS AND SUSPENSION



UNIQUE SUSPENSION
TECHNOLOGY

COMFORTABLE
AND DYNAMIC

XE responds with agility and performs with dynamism while always maintaining ride comfort - it's a unique balance that makes it a Jaguar. The ideal foundation for these driving dynamics is XE's light, yet exceptionally strong and stiff, Lightweight Aluminium Architecture with its near 50:50 weight distribution.

The sophisticated front and rear suspension systems complete a chassis that achieves a superb combination of sportiness and refinement. Advanced damper technologies - both passive and adaptive - improve ride quality still further and extend XE's breadth of dynamic capability. The suspension's control, agility and feedback give XE the spirit of a sports car.

BRAKE SCOOP

A glass-filled polypropylene brake scoop channels air onto the brakes for enhanced brake performance during enthusiastic driving.

INTEGRAL LINK REAR SUSPENSION

Integral Link rear suspension allows XE to realise a perfect combination of a refined, luxurious ride and sharp, responsive handling. The system, the benchmark for this class of car, separates and independently manages the lateral, longitudinal and vertical forces acting on the suspension for enhanced control and comfort. Many components are forged or hollow-cast in aluminium - the optimum production techniques for strong, lightweight suspension.

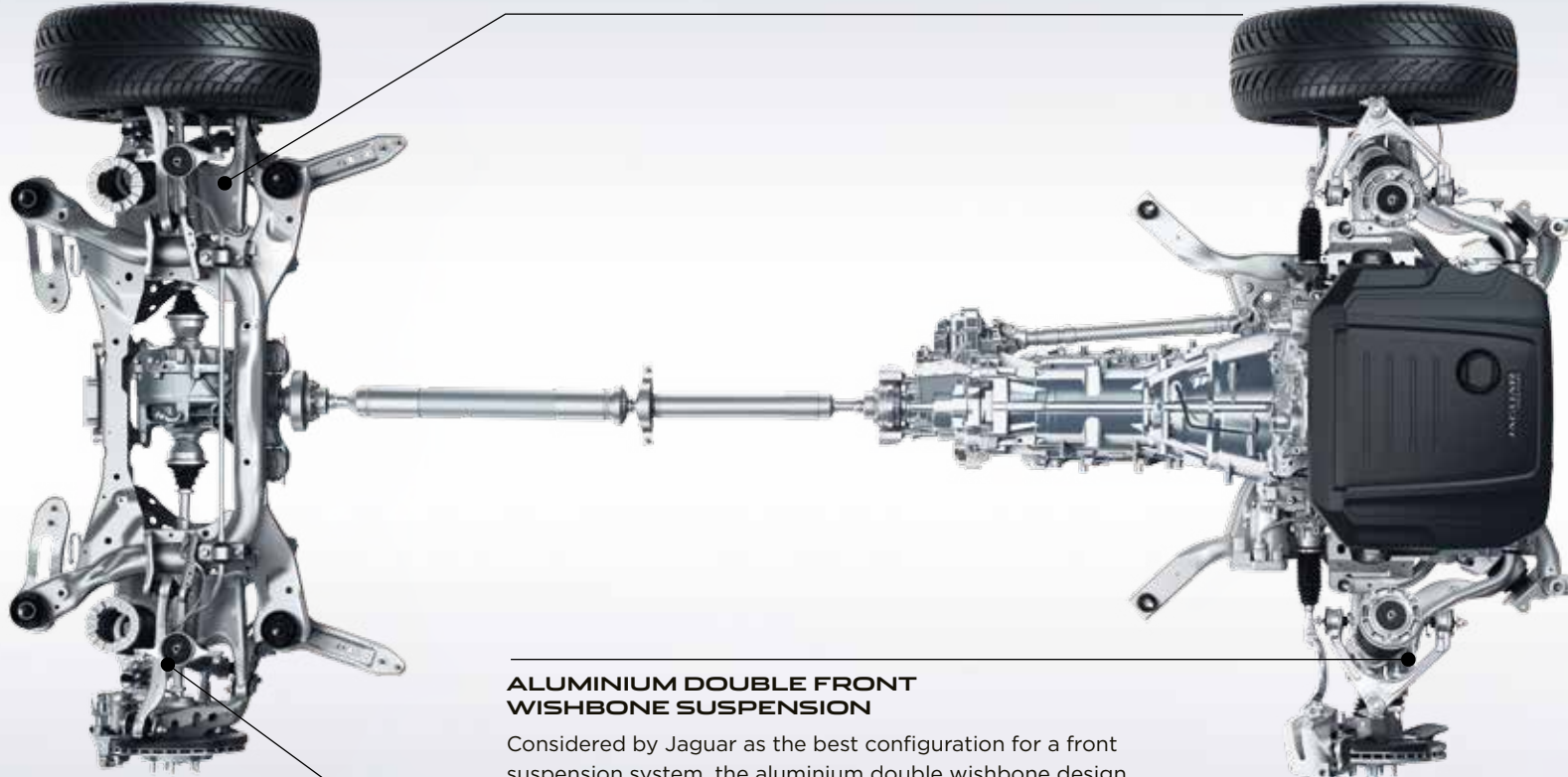

ALUMINIUM DOUBLE FRONT WISHBONE SUSPENSION

Considered by Jaguar as the best configuration for a front suspension system, the aluminium double wishbone design is modelled closely on F-TYPE's for precise handling and steering response.

ADAPTIVE DYNAMICS

The optional Adaptive Dynamics system delivers both precise dynamics and a supple, luxurious ride by monitoring wheel position and body movements. The system adjusts the dampers to provide the optimum balance between comfort and refinement at all times.



DRIVING TECHNOLOGY ADVANCED DRIVING DYNAMICS



MAXIMISING AGILITY

CONTINUOUSLY ADAPTING

ELECTRIC POWER ASSISTED STEERING

XE's next generation Electric Power Assisted Steering (EPAS) offers outstanding feedback, control and immediate power assistance. It is active on demand - saving power for when you really need it, as well as saving fuel. Allowing sophisticated computer management to adapt the levels of steering support, EPAS gives you fine control at speed and comprehensive assistance during slow manoeuvring. It also enables advanced optional safety features such as Lane Keep Assist and Park Assist.

ADAPTIVE DYNAMICS

Whether you're accelerating on the motorway, cornering on country roads or navigating around town, optional Adaptive Dynamics modifies XE's response to match the conditions and your driving style. It analyses acceleration, cornering, throttle and brake pedal activity, as well as kick-down activation. Steering and body movement are also analysed up to 500 times a second. Using this information, electronically controlled adaptive dampers then constantly adjust to optimise the suspension settings and maintain XE's poise and comfort.

NEXT GENERATION BRAKING

XE's next generation braking system is optimised for high performance and to save weight. Air deflectors fitted to the front suspension efficiently channel air to cool the brakes and reduce the risk of fade during enthusiastic driving. While new technology in the pads reduces dust to improve refinement, increase disc life and maintain the clean appearance of the wheels.

ALL SURFACE PROGRESS CONTROL

ADDED DRIVER CONFIDENCE

Unique in this class of car, Jaguar's All Surface Progress Control (ASPC) technology is a low speed cruise control that helps XE to cope with low traction situations. ASPC allows the driver to concentrate on steering the vehicle. Once activated, you use the cruise control buttons to set a 'target' speed of between 3.6km/h and 30km/h. The system then works to achieve and maintain that speed while exerting optimum traction control. ASPC is available on all engines fitted with automatic transmissions and gives XE drivers added confidence over slippery, loose or icy surfaces, undulating terrain and even while descending a difficult incline. It helps make XE easy to drive in challenging conditions. ASPC also has a pull-away function allowing XE to progress from rest on slippery surfaces and ascending gradients, as well as a hill descent function that controls vehicle speed on steeper inclines.

With any given set of tyres, ASPC can accomplish comparable levels of traction to that achievable by an expert driver. Fitting All Season or Winter tyres to XE can improve capability on slippery surfaces.



MUD/GRAVEL



WET GRASS



SNOW/ICE



WET ROAD

DRY ROAD CONDITIONS

In normal driving conditions, virtually all torque is distributed to the rear wheels providing signature Jaguar Rear Wheel Drive performance.

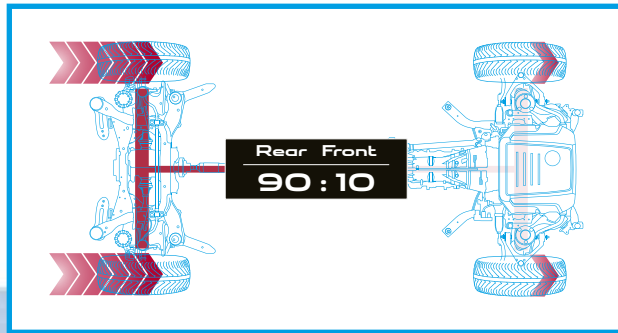

LOW TRACTION CONDITIONS

On slippery surfaces, such as grass and mud, torque can be balanced 50:50 between the front and rear wheels to maximise traction.

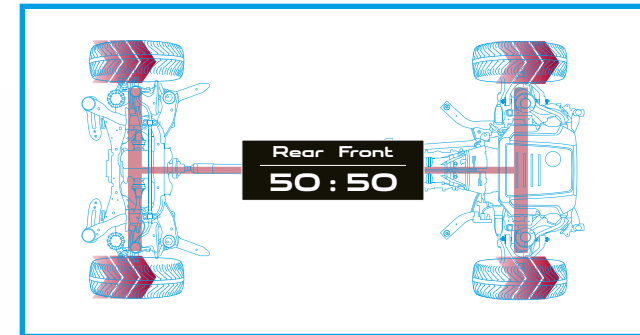

VARIABLE ROAD CONDITIONS

Where road conditions are changeable, over 90 percent of torque can be intelligently distributed from the rear wheels to the front to optimise traction in all conditions.

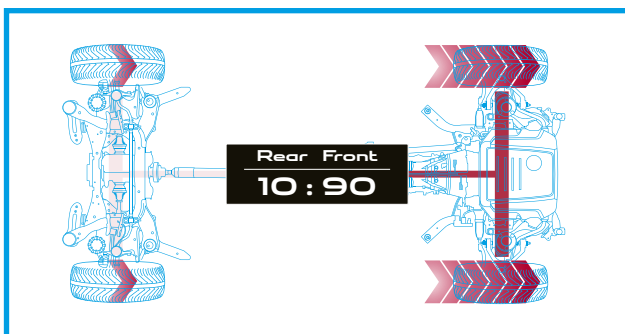

ADVANCED DRIVETRAIN TECHNOLOGY



ALL WHEEL DRIVE

ADAPTIVE SURFACE RESPONSE

XE's All Wheel Drive (AWD) system delivers confident handling on all surfaces. The drivetrain technology offers a reduction in weight and an increase in efficiency compared to previous generation systems. At its heart is an extremely fast-reacting, compact transfer case with integrated Intelligent Driveline Dynamics (IDD) software. Exclusively developed by Jaguar, the unique IDD software features sophisticated algorithms to react intelligently to road conditions for traction on demand. Whenever greater traction is needed, IDD ensures that precisely the right amount of torque is transferred to the front wheels – a process that takes no more than 165 milliseconds. Offering a smoother, safer drive, the system also consumes less fuel and has lower emissions than permanent AWD. Predictive, as well as reactive, the system helps prevent you from losing traction instead of working to regain it.

On AWD vehicles fitted with Adaptive Dynamics, optional Adaptive Surface Response (AdSR) recognises differences between surfaces to exploit the maximum available grip. Drawing on Jaguar Land Rover's unrivalled expertise with AWD systems, AdSR constantly monitors the car's environment and adjusts the appropriate engine and brake settings. Once selected, AdSR works at all speeds to support you in adverse weather and across challenging surfaces.



TORQUE VECTORING APPLIES
BRAKE PRESSURE TO SLOW THE
INSIDE FRONT AND INSIDE REAR
WHEELS INDEPENDENTLY.

POWER IS SUSTAINED
TO MAINTAIN CONSTANT
SPEED OF OUTER WHEELS.

TORQUE VECTORING



TORQUE VECTORING BY BRAKING

XE's Torque Vectoring by braking maximises capability through even the tightest of corners. Torque Vectoring technology provides controlled independent braking on the individual inside front and rear wheels to add to the turning forces acting on the car. In most conditions more braking pressure is applied to the rear inside wheel as this supports the most increased cornering capability, while the front inside wheel is braked for greater effectiveness and refinement. The result is reduced understeer for sharper turning and more consistent road holding. Torque Vectoring delivers increased sports car-like agility and added driver confidence.

ADDITIONAL ROTATIONAL
FORCE APPLIED AROUND
VEHICLE'S AXIS.

VEHICLE SHOWN: XE S IN ITALIAN RACING RED WITH OPTIONAL FEATURES FITTED (MARKET DEPENDENT)

STABILITY AND CONTROL



DYNAMIC STABILITY CONTROL

ENGINE DRAG TORQUE CONTROL

TRAILER STABILITY ASSIST

Jaguar's Stability Systems keep XE safely balanced whether you're driving enthusiastically or simply want the assurance of a car that will remain stable in challenging conditions.

Dynamic Stability Control (DSC) monitors XE's dynamic behaviour, intervening to maximise vehicle stability and optimising available grip. DSC reduces engine torque and applies braking to the appropriate wheels to correct the car's direction of travel by counteracting understeer or oversteer. XE's DSC system has enhanced understeer control to reduce speed and regain control more effectively.

Engine Drag Torque Control (EDC) mitigates the chance of wheel slip caused by strong engine braking in adverse driving conditions. It acts by briefly increasing torque to the wheels as appropriate.

Trailer Stability Assist (TSA) gives you greater stability when towing. Should TSA detect a dangerous trailer sway situation is developing, it can help you regain control by gradually reducing XE's speed through lowering engine power and applying the brakes individually on each side of the vehicle to control the sway.

UNDERSTEER

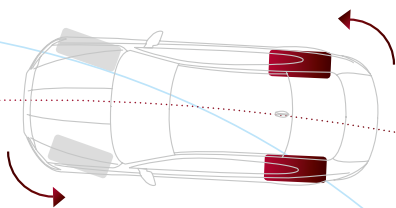
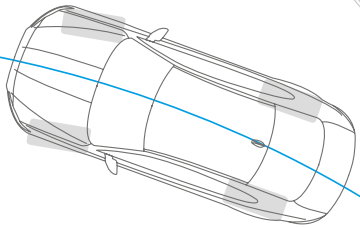
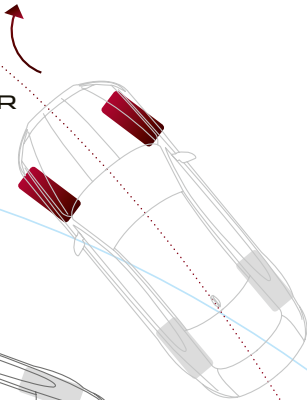

OVERSTEER

BRAKING APPLIED TO APPROPRIATE WHEELS TO COUNTERACT UNDERSTEER/OVERSTEER

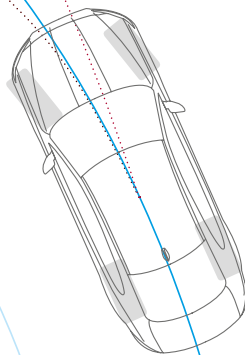

VEHICLE SHOWN: XE S IN ITALIAN RACING RED WITH OPTIONAL FEATURES FITTED (MARKET DEPENDENT)





HEAD-UP DISPLAY

> HEAD-UP DISPLAY WITH LASER TECHNOLOGY

The optional Head-Up Display (HUD) with laser technology projects key information onto the windscreen. Remaining clear even in direct sunlight, the crisp, bright image can display vehicle speed, navigation, cruise control notifications and Traffic Sign Recognition data, where available. This technology helps you minimise time spent looking down at the instrument cluster and can help you maintain continuous awareness of the car's speed.

ADAPTIVE CRUISE CONTROL

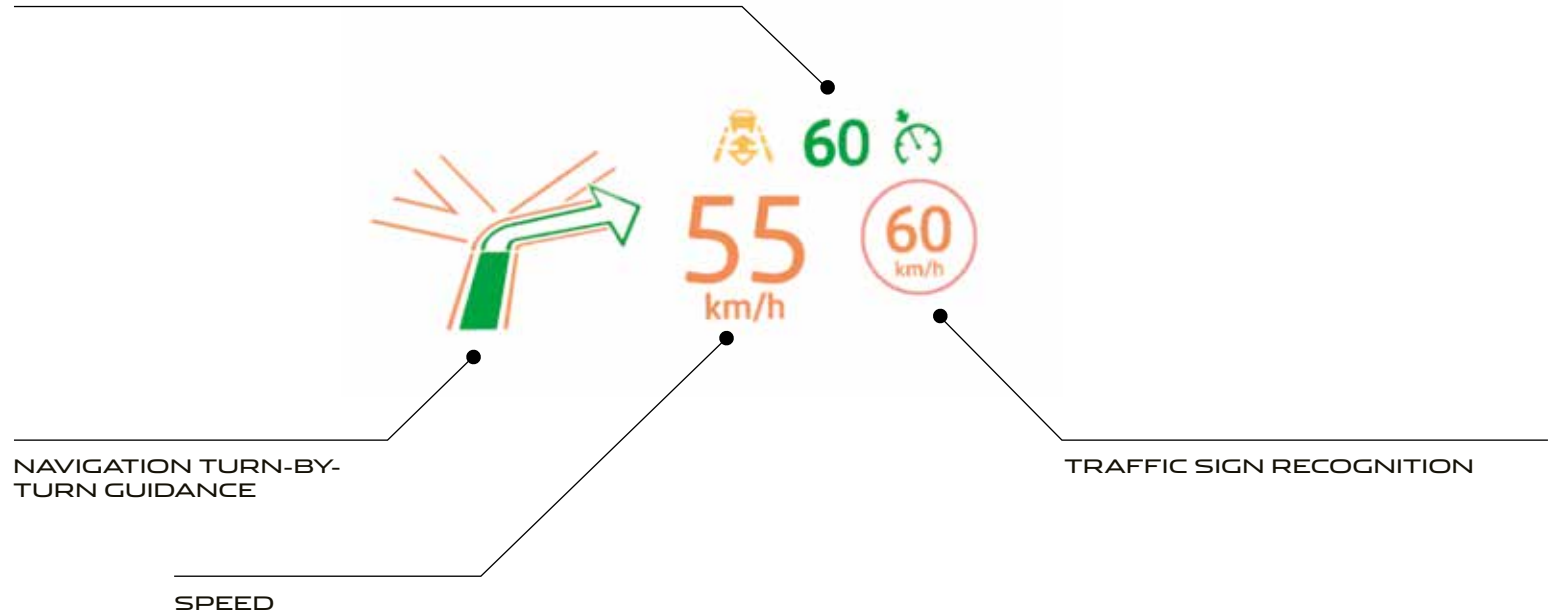

INFOTAINMENT INCONTROL TECHNOLOGIES

 INCONTROL TOUCH | INCONTROL TOUCH PRO

InControl is our suite of advanced technologies that links both you and your XE to the wider world. Choose from two InControl infotainment systems: InControl Touch as standard, or upgrade to InControl Touch Pro*. These can be further enhanced by adding their respective connectivity packages, InControl Connect* and InControl Connect Pro*.

*As we systematically introduce InControl, specific features, options and its availability remain market dependent.

**Only available with InControl Apps or InControl Connect Pro (see optional connectivity packages for InControl Touch Pro).

†Supports compatible music players.

Third Party programmes or applications may require an end user license from the supplier.



INCONTROL TOUCH



STANDARD ON EVERY XE

8 inch Touch-screen
 Jaguar Sound System (80W)
 FM Radio
 USB+, Bluetooth® and AUX connections



InControl Protect consists of
 SOS Emergency Call, Jaguar Optimised Assistance
 and Remote Essentials smartphone app



OPTIONAL

InControl Connect consists of InControl Apps,
 Remote Premium smartphone app and Wi-Fi Hotspot



InControl Secure provides stolen vehicle monitoring and
 notifications via your smartphone and the secure call centre

ADDITIONAL OPTIONS

Meridian Sound System (380W)
 InControl Touch SD Navigation
 DAB Radio

For information on InControl Touch see pages 44-45.



INCONTROL TOUCH PRO



AVAILABLE AS AN UPGRADE

10.2 inch Touch-screen with multi-touch gestures
 and customisable homescreen
 InControl Touch Pro Solid State Drive (SSD) Enhanced Navigation
 Meridian Digital Sound System (380W)
 FM Radio, Bluetooth® and 2 x USB+ connections
 10GB of onboard dedicated media storage
 CD/DVD Drive



InControl Protect consists of
 SOS Emergency Call, Jaguar Optimised Assistance
 and Remote Essentials smartphone app



OPTIONAL

InControl Connect Pro consists of InControl Apps, Remote
 Premium smartphone app, Wi-Fi Hotspot and Pro Services



InControl Secure provides stolen vehicle monitoring and
 notifications via your smartphone and the secure call centre

ADDITIONAL OPTIONS

Meridian Digital Surround Sound System (825W)
 Digital TV, HDMI**, MHL**
 DAB Radio

For information on InControl Touch Pro see pages 46-47.



8 INCH TOUCH-SCREEN SHOWN AT ACTUAL SIZE

Audio	Standard: Jaguar Sound System (80W) Optional: Meridian Sound System (380W)
Navigation Guidance	InControl Touch SD Navigation*
Display	8 inch Touch-screen
Multimedia	FM and DAB Radio*, USB**, Bluetooth® and AUX connections
Standard InControl Package	InControl Protect consists of SOS Emergency Call, Jaguar Optimised Assistance and Remote Essentials smartphone app
Optional Connectivity Package	InControl Connect consists of InControl Apps, Remote Premium smartphone app and Wi-Fi Hotspot

*Optional features. **Supports compatible music players. †Only when Navigation is fitted. ‡Market Dependent.

As we systematically introduce InControl, specific features, options and its availability remain market dependent. Please consult your local Jaguar retailer for further details. Wi-Fi Hotspot requires the fitment of a Standard SIM with a suitable data contract.

INCONTROL TOUCH



ADVANCED INFOTAINMENT AS STANDARD

The InControl Touch multimedia system is XE's hub for connectivity, control and entertainment. The key features are:

8 inch Touch-screen at the heart of the centre console. Clear and responsive graphical interface for quick control.

Easy to use Touch-screen responds directly to touch and swipe gestures.

Navigation guidance* makes planning journeys and following routes easy, thanks to turn-by-turn voice guidance, junction view and 3D maps. 'Dead-reckoning' functionality can accurately position the vehicle even when GPS signals can no longer be received – perfect for city centres or driving through tunnels.

Bluetooth phone connectivity allows you to link and control your smartphone via InControl Touch either for phone calls or music playback: simple, easy and wire-free.

Access a world of music thanks to FM, DAB, Satellite and HD radio (subject to regional fitment), as well as USB** and AUX connections.

Integrated text-to-voice† technology reduces distraction by reading out incoming text messages. You can easily respond with short, prepared messages.

Precise climate control is available via the Touch-screen. Adjust temperature levels, direction and intensity of airflow and operate heated or climate seats (if fitted).

INCONTROL CONNECT



OPTIONAL CONNECTIVITY PACKAGE

InControl Connect is a bundle of technologies and applications that takes your XE's connectivity to the next level.

InControl Apps features a range of bespoke Jaguar approved apps that can be connected to the car from your smartphone. It ensures the safe and convenient use of these apps that have been optimised specifically to enhance aspects of your in-car experience.

Wi-Fi Hotspot gives you the option to create a 3G hotspot using the car's antenna when you fit a SIM card. This strengthens your link to the outside world, for a more stable connection than an individual device could maintain. Connect up to eight devices to read emails, browse the web and download content.

Remote Premium is a multi-function app that allows you to monitor as well as interact with your XE from your smartphone. Remote start the engine to pre-condition the climate‡ (with automatic transmission), lock and unlock the car, locate your XE on a map or by using the beep and flash function, and track your journeys – all via the app.



Explore InControl at jaguar.com/incontrol



10.2 INCH TOUCH-SCREEN SHOWN AT ACTUAL SIZE

Audio	Standard: Meridian Digital Sound System (380W) Optional: Meridian Digital Surround Sound System (825W)
Navigation Guidance	InControl Touch Pro SSD Enhanced Navigation
Display	10.2 inch Capacitive Touch-screen
Multimedia	FM and DAB Radio*, Bluetooth®, HDMI†, MHL† and 2 x USB** connections. Digital TV*, 10GB of usable memory and CD/DVD Drive
Standard InControl Package	InControl Protect consists of SOS Emergency Call, Jaguar Optimised Assistance and Remote Essentials
Optional Connectivity Packages	InControl Connect Pro consists of InControl Apps, Remote Premium, Wi-Fi Hotspot and Pro Services (including Route Planner Companion App, share your destination and ETA, Commute Mode, Arrival Mode, real time traffic information, fuel and parking services, and satellite and street level imagery where available)

*Optional features. **Supports compatible music players. †Only available with InControl Apps or InControl Connect Pro (see optional connectivity packages for InControl Touch Pro). ‡Market Dependent.

As we systematically introduce InControl, specific features, options and its availability remain market dependent.

Please consult your local Jaguar retailer for further details. Certain InControl Connect Pro features require the fitment of a Micro SIM with a suitable data contract.

INCONTROL TOUCH PRO

UPGRADE TO NEXT GENERATION INFOTAINMENT

InControl Touch Pro's next generation hardware and software advances XE's connectivity and entertainment to the very highest level. InControl Touch Pro's features enhance those found in InControl Touch. The key aspects of InControl Touch Pro are:

Larger, highly-responsive, 10.2 inch Touch-screen at the heart of the centre console with customisable home screen and lightning fast response times. Its interactive side panel makes multi-tasking easy.

Pinpoint touch control allows you to manipulate and interact with information swiftly and seamlessly. The Touch-screen responds in the same manner as a smartphone or tablet computer, providing multi-touch gestures such as pinch to zoom and swipe.

Enhanced Navigation with response times that are a fraction of conventional systems. One of the many innovative features of InControl Touch Pro's Navigation is that it allows you to set a destination and the system alerts you if you have insufficient fuel for the journey. It then displays filling stations on the part of the route where you may be low on fuel. The system automatically displays parking options where available.

Personal media storage of 10GB of usable memory for your music and movies. 'Plug and play' using the two USB ports allowing for fast transfer speeds.

 Explore InControl at jaguar.com/incontrol

INCONTROL CONNECT PRO

OPTIONAL ENHANCED CONNECTIVITY PACKAGE

InControl Connect Pro's services, technologies and applications give you the very best in connectivity and convenience. It offers all the benefits of InControl Connect (see page 45) plus many more features, including:

Route Planner Companion App offers true door-to-door navigation. Pre-plan your destination and route via your Apple or Android smartphone. The app will guide you to your car, where you will find your selected route available on the car's Touch-screen. When you've completed your road journey, the app can guide you by foot or public transport (where supported) to your destination.

Share your estimated time of arrival so your selected contact(s) will know exactly when you will arrive, as calculated by the navigation guidance system. If you're running late, the system can then send automatic updates via text or email, without any further action from you.

Commute Mode allows the system to learn your commutes and automatically advises you of the expected journey time based on live and historical traffic movements. The system learns the routes you take for a given destination and then advises which of those is the quickest.

Arrival Mode displays interactive 360° street level imagery¹ of your destination for seamless finishes to journeys. It automatically displays again upon your arrival. You then simply tap the Touch-screen to select a nearby car park, which appears as an updated destination.

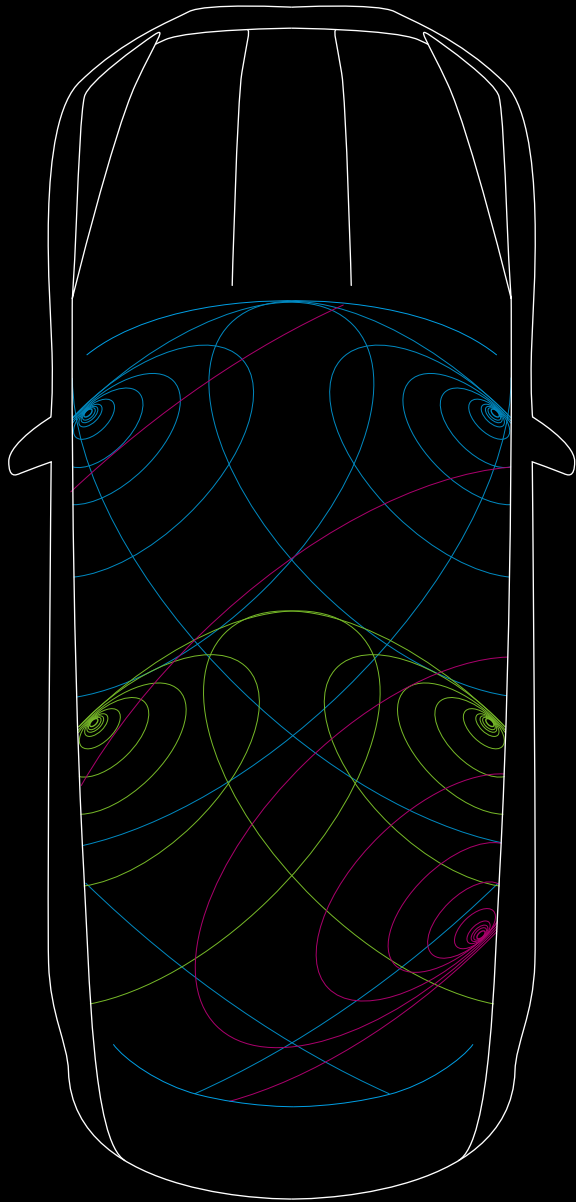

AUDIO



JAGUAR
SOUND SYSTEM

MERIDIAN DIGITAL
SOUND SYSTEM

XE's superb sound systems bring your music to life. Offering an enhanced listening experience are the optional Meridian Sound Systems. Designed in conjunction with the British audio experts Meridian, these systems use innovative audio technology and precise speaker placement to give perfectly optimised sound quality.

Choose from a range of audio systems, including the new digital 380W Sound System with 11 speakers or the new digital 825W Surround Sound System with 17 speakers. All systems ensure that, wherever you or your passengers sit in your XE, everyone will enjoy a rich, enveloping audio experience.



-  Fresh air subwoofer
-  Front door waves tweeter midrange bass
-  Rear door waves tweeter midrange

Diagram representative of Meridian 380W Sound System.



MERIDIAN

SOUND SYSTEMS AVAILABLE IN CONJUNCTION WITH **INCONTROL TOUCH**

Standard

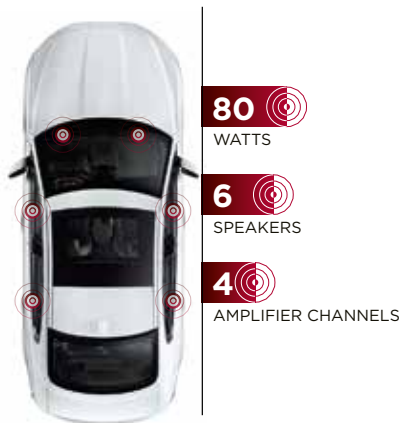

JAGUAR SOUND SYSTEM

Speed Dependent Volume*
80 watts
6 speakers
4 amplifier channels

Optional

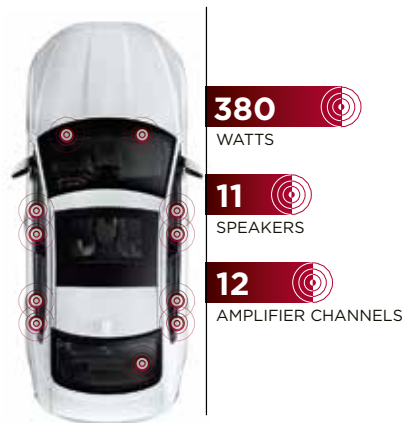

MERIDIAN SOUND SYSTEM

Speed Dependent Volume*
380 watts
11 speakers including sub woofer
12 amplifier channels

SOUND SYSTEMS AVAILABLE IN CONJUNCTION WITH **INCONTROL TOUCH PRO**

Standard

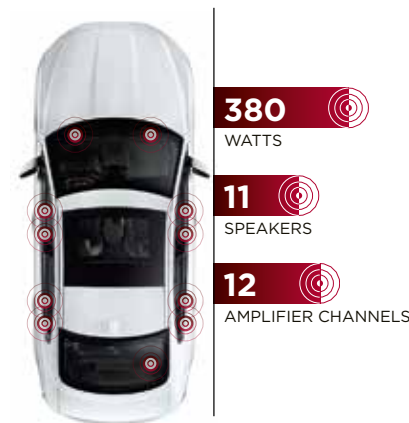

MERIDIAN DIGITAL SOUND SYSTEM

Dynamic Volume Control**
380 watts
11 speakers including sub woofer
12 amplifier channels
Advanced DSP with fully digital amplification
Audyssey MultEQ Audio Equalisation

Optional

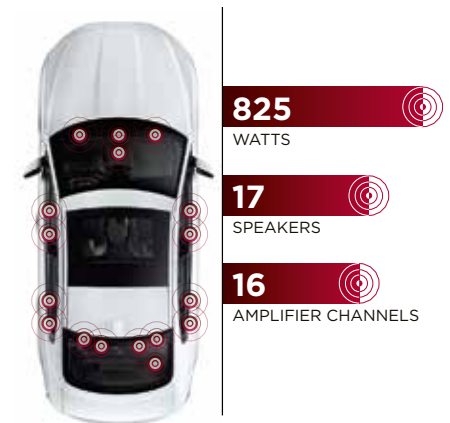

MERIDIAN DIGITAL SURROUND SOUND SYSTEM

Dynamic Volume Control**
825 watts
17 speakers including sub woofer
16 amplifier channels
Advanced DSP with fully digital amplification
Audyssey MultEQ Audio Equalisation
Meridian Trifield Technology

*Automatically adjusts as vehicle speed changes.

**Automatically adjusts as vehicle speed changes and/or ambient noise levels change.

VEHICLE SHOWN: XE PURE IN GLACIER WHITE WITH OPTIONAL FEATURES FITTED (MARKET DEPENDENT)

SAFETY AND EFFICIENCY ADVANCED DRIVER ASSISTANCE



1 AUTONOMOUS EMERGENCY BRAKING*

Should a potential collision be detected, XE gives an audible forward collision warning. Visual warnings follow. If the driver takes no action, the system applies the brakes to help reduce the severity of the possible impact.

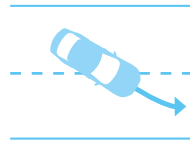

2 LANE DEPARTURE WARNING*

Lane Departure Warning (LDW) notifies the driver with a visual alert and a gentle vibration of the steering wheel should the car detect an unintentional drift from its lane, helping to keep everyone on board safe.



3 LANE KEEP ASSIST AND DRIVER CONDITION MONITOR**

Building on Lane Departure Warning, Lane Keep Assist (LKA) senses unintentional lane drift and helps steer XE back into its lane. Driver Condition Monitor (DCM) detects lapses in concentration due to tiredness by monitoring driver inputs and suggests taking a break via an audible alert and a visual notification in the instrument cluster.



4 TRAFFIC SIGN RECOGNITION AND ADAPTIVE SPEED LIMITER**

Traffic Sign Recognition technology detects speed limits, including variable limits, and no overtaking signs via the forward-facing camera, then displays them to the driver. The Adaptive Speed Limiter uses detected traffic sign information to help keep XE within the appropriate speed limit. Where no traffic sign is detected, the Adaptive Speed Limiter can also use the map data from the optional navigation system.



5 BLIND SPOT MONITOR AND REVERSE TRAFFIC DETECTION**

Blind Spot Monitor alerts you to vehicles or obstacles beside XE, as well as ones approaching from a distance behind, via an icon displayed in the appropriate exterior mirror. Reverse Traffic Detection extends the Blind Spot Monitor function and alerts you via the Touch-screen of moving vehicles during reversing - for example, when leaving a parking bay with restricted vision.

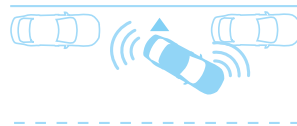

6 PARK ASSIST**

Park Assist makes parking in tight spaces easier than ever. XE can accurately steer itself during both parallel and bay parking manoeuvres - the driver only has to control the brakes and accelerator. An exit-assist function can help guide XE while leaving a parallel space.

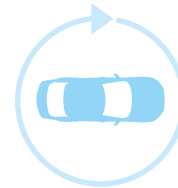

7 SURROUND CAMERA SYSTEM**

Surround Camera System gives you 360° exterior vision on the Touch-screen. This helps with various manoeuvres from parking by a kerb to getting in and out of tight spaces and junctions.

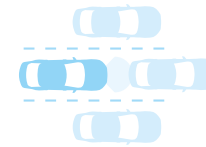

8 ADAPTIVE CRUISE CONTROL WITH QUEUE ASSIST**

Adaptive Cruise Control[†] uses radar technology to automatically adjust your speed to maintain a safe distance from the vehicle ahead. If that vehicle slows, your XE reduces its speed to maintain a safe distance. XE resumes its pre-set speed as soon as the road in front is clear. Should the car in front stop completely, the Queue Assist function brings XE to a smooth halt. Once the traffic moves off, touch the accelerator and XE will follow the car in front again.

*Standard feature (Market dependent).
**Optional features, availability and fitment is market dependent.
†Only available on automatic transmission.

VEHICLE SHOWN: XE PURE IN GLACIER WHITE WITH OPTIONAL FEATURES FITTED (MARKET DEPENDENT)

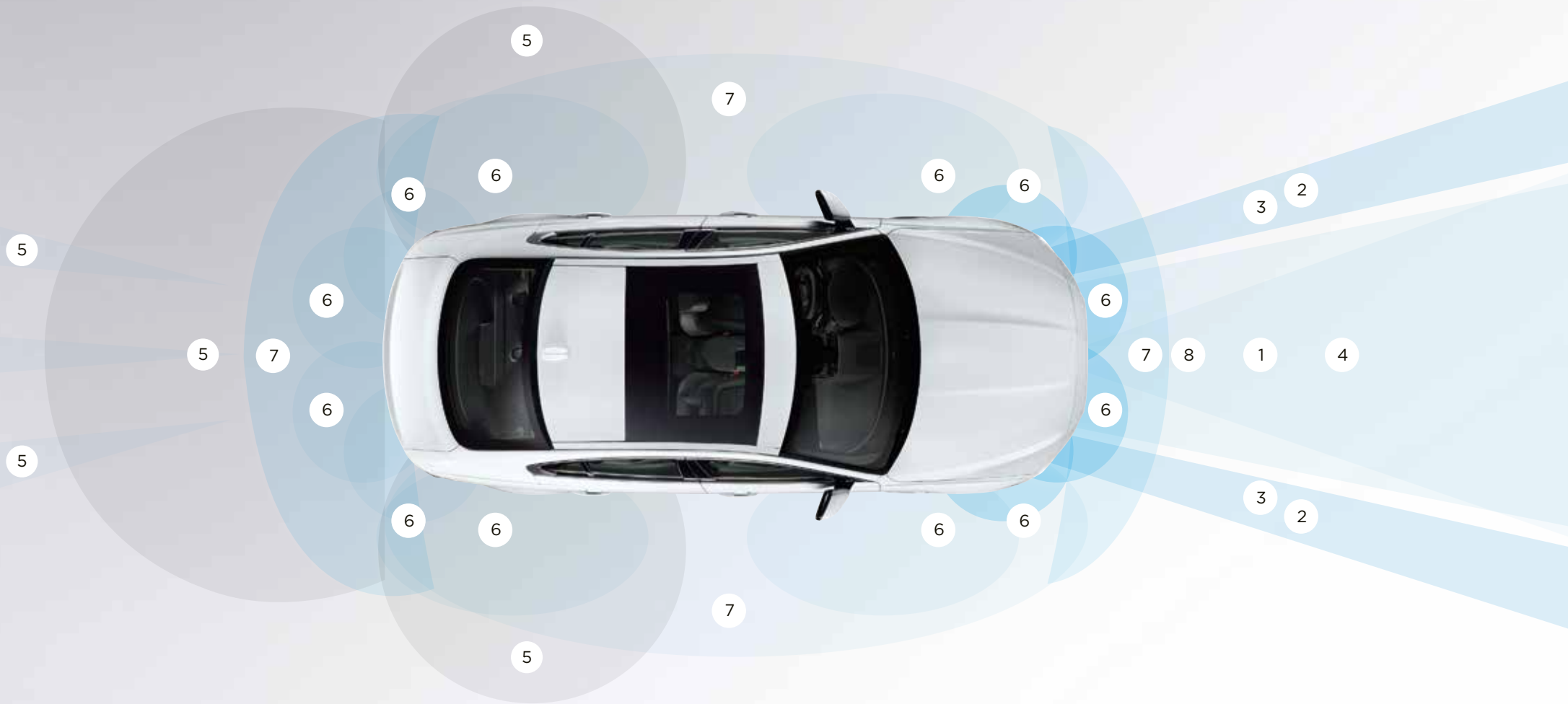

Graphical representation only.

EFFICIENT TECHNOLOGIES



LOW FRICTION

CLEAN TECHNOLOGIES

Everyone wants to do more with less. That is why XE uses a range of technologies to reduce fuel consumption and CO₂ emissions, all while staying true to Jaguar's dynamic nature.



E-PERFORMANCE

The 2.0 litre 4-cylinder turbocharged diesel (163PS) makes use of Jaguar's highly refined and efficient Ingenium powertrain and has aerodynamic additions to the front and underbody areas. It also uses Ultra Low Rolling Resistance tyres to reduce drag between road and tyre as well as lightweight alloy wheels designed for optimised weight. This allows XE to reduce CO₂ emissions to as low as 99g/km.



STOP/START

All XE's engines are available with Stop/Start**. It shuts down the engine when you come to a complete halt and restarts the engine immediately when required to help save fuel, especially during urban driving.

*Available only on E-Performance models. This is market dependent.
**This is market dependent.



17" ALLOY WHEELS

XE is available with both a Lightweight and Aerodynamic wheel*, with Ultra Low Rolling Resistance tyres to maximise efficiency without loss of Jaguar's legendary comfort.



ADVANCED AERODYNAMICS

XE can offer an incredibly low drag co-efficient of Cd 0.26. This helps XE cut through the air with ease, meaning less work for the engine and therefore reduced fuel consumption and emissions.

AdBlue®

ADBLUE®**

XE's diesel models are fitted with AdBlue® to help clean exhaust gases. AdBlue® is a non-toxic, non-flammable, biodegradable additive that cleanses the gases in the car's exhaust system to remove harmful nitrogen oxide emissions.



LOW FRICTION TECHNOLOGIES

Technologies such as smart coatings on XE's pistons and needle roller bearings in the Ingenium engine range help to reduce friction, particularly at low engine temperatures. This helps the car perform at its efficient best.

PERSONALISATION XE - YOUR CHOICE

 Configure your vehicle at jaguar.com



CHOOSE YOUR ENGINE

Page 56

Select one of XE's powerful, efficient petrol or diesel engines to suit your driving style.

CHOOSE YOUR MODEL & OPTIONS

Page 58

Compare the wealth of standard features and options on XE models.

CHOOSE YOUR COLOUR

Page 66

Express your individuality with one of XE's stunning exterior colours.

CHOOSE YOUR WHEELS

Page 68

Add the personal finishing touch to your new XE, and complement its stunning style, with a set of beautifully designed alloy wheels.

CHOOSE YOUR INTERIOR

Page 70

There's a wide selection of premium materials, leathers, veneers and finishes for every personal taste.

CHOOSE YOUR JAGUAR ACCESSORIES

Page 88

Really make it yours by adding style, practicality and versatility with official XE Accessories from your local Jaguar Retailer.

1 CHOOSE YOUR ENGINE

 Configure your vehicle at jaguar.com

> DIESEL ENGINES

2.0 LITRE 4-CYLINDER TURBOCHARGED E-PERFORMANCE

MAXIMUM POWER 163PS
MAXIMUM TORQUE 380Nm
ACCELERATION 0-100 km/h Manual 8.4 seconds / Automatic 8.2 seconds
TOP SPEED Manual 227 km/h / Automatic 227 km/h
COMBINED Manual 3.8 l/100km Automatic 4.1 l/100km
CO ₂ EMISSIONS Manual 99 g/km Automatic 106 g/km
PURE, PRESTIGE, PORTFOLIO, R-SPORT

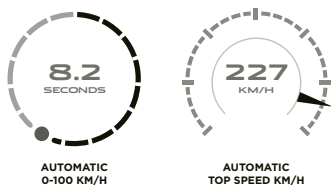
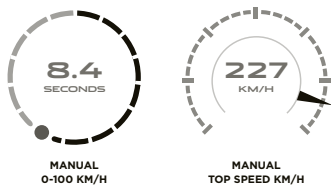

2.0 LITRE 4-CYLINDER TURBOCHARGED

MAXIMUM POWER 180PS
MAXIMUM TORQUE 430Nm
ACCELERATION 0-100 km/h Manual 7.8 seconds / Automatic 7.8 seconds
TOP SPEED Manual 231 km/h / Automatic 228 km/h
COMBINED Manual 4.2 l/100km Automatic 4.2 l/100km
CO ₂ EMISSIONS Manual 109 g/km Automatic 109-111 g/km
PURE, PRESTIGE, PORTFOLIO, R-SPORT

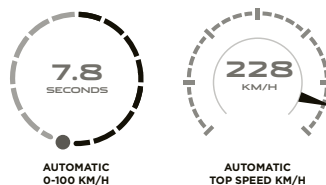
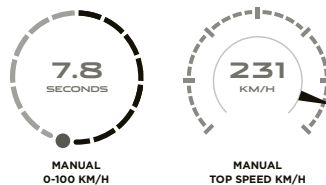

2.0 LITRE 4-CYLINDER AWD TURBOCHARGED

MAXIMUM POWER 180PS
MAXIMUM TORQUE 430Nm
ACCELERATION 0-100 km/h Automatic 7.9 seconds
TOP SPEED Automatic 225 km/h
COMBINED 4.7 l/100km
CO ₂ EMISSIONS 123 g/km
PURE, PRESTIGE, PORTFOLIO, R-SPORT

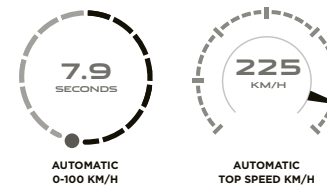

Please refer to Technical Specification pages for full fuel consumption figures.
The figures provided are as a result of official manufacturer's tests in accordance with EU legislation.
A vehicle's actual fuel consumption may differ from that achieved in such tests and these figures are for comparative purposes only.

> PETROL ENGINES

2.0 LITRE

4-CYLINDER TURBOCHARGED

MAXIMUM POWER 200PS

MAXIMUM TORQUE 320Nm

ACCELERATION 0-100 km/h 7.7 seconds

TOP SPEED 237 km/h

COMBINED 7.5 l/100km

CO₂ EMISSIONS 179 g/km

PURE, PRESTIGE, PORTFOLIO, R-SPORT

2.0 LITRE

4-CYLINDER TURBOCHARGED

MAXIMUM POWER 240PS

MAXIMUM TORQUE 340Nm

ACCELERATION 0-100 km/h 6.8 seconds

TOP SPEED 250 km/h

COMBINED 7.5 l/100km

CO₂ EMISSIONS 179 g/km

PURE, PRESTIGE, PORTFOLIO, R-SPORT

3.0 LITRE V6

SUPERCHARGED

MAXIMUM POWER 340PS

MAXIMUM TORQUE 450Nm

ACCELERATION 0-100 km/h 5.1 seconds

TOP SPEED 250 km/h

COMBINED 8.1 l/100km

CO₂ EMISSIONS 194 g/km

S



0-100 KM/H

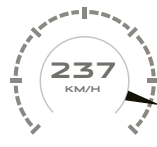

TOP SPEED KM/H



0-100 KM/H

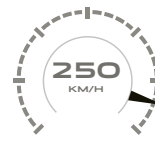

TOP SPEED KM/H



0-100 KM/H



TOP SPEED KM/H

2 CHOOSE YOUR MODEL

 Configure your vehicle at jaguar.com

LUXURY



PURE

KEY FEATURES

- 17" Turbine 10 Spoke alloy wheels
- 17" Lightweight 15 Spoke alloy wheels (E-Performance*)
- Premium Cloth seats (8-way manual)
- Gloss Black trim finishers
- Multi-Function Grained Leather steering wheel
- All Surface Progress Control (Automatic Transmission only)
- Cruise Control and Speed Limiter
- Halogen Headlights with Daytime Running Lights
- Heated door mirrors
- Treadplates with Jaguar script
- Black radiator grille with Chrome surround



PRESTIGE

KEY FEATURES (IN ADDITION TO PURE)

- Taurus Leather seats
- Rear armrest with twin cupholders
- Dark Satin Brushed Aluminium trim finisher
- Multi-Function Softgrain Leather steering wheel
- Metal treadplates with Jaguar script



PORTFOLIO

KEY FEATURES (IN ADDITION TO PRESTIGE)

- 18" Arm 6 Spoke alloy wheels
- Perforated Windsor Leather seats (10-way electric)
- Cuir Grain wrapped dashboard
- Embossed Aluminium trim finisher
- Bi-function Xenon headlights
- Headlight Powerwash
- Gloss Black radiator grille with Chrome surround

*Market dependent.

Images feature optional equipment. Please note that standard features may be replaced when selecting alternative trim levels. Standard features may also vary depending on country of purchase, engine variant and transmission, please refer to Specification and Price Guide or website for your local market.

> SPORT



R-SPORT

KEY FEATURES (IN ADDITION TO PRESTIGE)

- 18" Star 5 Spoke alloy wheels
- Luxtec and Technical Mesh Sport seats (8-way manual)
- R-Sport branded Multi-Function Softgrain Leather steering wheel
- Black radiator grille with Satin Chrome surround
- Etched Aluminium trim finishers
- R-Sport bodykit - R-Sport front bumper, Body-coloured extended side sills, Satin Chrome side power vents with R-Sport Badge and Bootlid Spoiler
- Metal treadplates with R-Sport branding
- Sports suspension



S

KEY FEATURES (IN ADDITION TO R-SPORT)

- 18" Templar 5 Twin Spoke alloy wheels
- Taurus Leather and Suedecloth Sport seats (10-way electric)
- S branded Multi-Function Softgrain Leather steering wheel
- Gloss Black radiator grille with Satin Chrome surround
- Taurus grain wrapped dashboard
- Meshed Aluminium trim finisher
- S Bodykit - S front bumper, S Body-coloured and Gloss Black extended side sills, S Gloss Black rear valance and Bootlid Spoiler
- Red brake calipers
- Bi-function Xenon headlights
- Metal treadplates with S branding
- Bright Sport pedals
- Adaptive Dynamics

2 CHOOSE YOUR OPTIONS

 Configure your vehicle at jaguar.com

KEY STANDARD FEATURES

	PURE	PRESTIGE	PORTFOLIO	R-SPORT	S	DESCRIPTION
Cruise Control and Speed Limiter	●	●	●	●	●	
Electric Power Assisted Steering (EPAS)	●	●	●	●	●	
Stop/Start*	●	●	●	●	●	Refer to page 52
JaguarDrive Control with Eco, Dynamic, Normal and Rain Ice Snow Mode	●	●	●	●	●	Refer to page 22
Torque Vectoring	●	●	●	●	●	Refer to page 37
Dynamic Stability Control and Traction Control	●	●	●	●	●	Refer to page 38
Hill Launch Assist	●	●	●	●	●	Prevents your XE from rolling backwards when pulling away on an incline, helping you to make the perfect hill start every time
Heated rear windscreen	●	●	●	●	●	
Heated door mirrors	●	●	●	●	●	
Partial LED tail lamps	●	●	●	●	●	
Jaguar Smart Key System – Keyless Start	●	●	●	●	●	
Power operated child locks	●	●	●	●	●	
ISOFIX anchor points for rear child seats	●	●	●	●	●	
Two-zone climate control	●	●	●	●	●	
Airbags	●	●	●	●	●	Driver and front passenger with seat occupant detector for passenger, front side and full length side window curtain
Autonomous Emergency Braking (requires Lane Departure Warning or Lane Keep Assist and Driver Condition Monitor)*	●	●	●	●	●	Refer to page 50
Lane Departure Warning*	●	●	●	●	●	Refer to page 50
Front and rear electric windows with one-touch open/close and anti-trap	●	●	●	●	●	
Electric Parking Brake with drive-away release	●	●	●	●	●	Automatically releases the parking brake without the need for driver input as you press the accelerator to drive away
Emergency Brake Assist	●	●	●	●	●	Increases braking pressure in an emergency situation
Hazard lights under heavy braking	●	●	●	●	●	
Brake pad wear indicator	●	●	●	●	●	
USB, Auxiliary socket and iPod® connectivity	●	●	●	●	●	Refer to page 43
Bluetooth® telephone connectivity	●	●	●	●	●	Refer to page 45
Bluetooth® streaming	●	●	●	●	●	Refer to page 45

*Market Dependant.

● Standard ○ Option — Not available ■ Option as part of Pack

Please consult your local Jaguar retailer for details.

For a complete list of optional features and packs refer to the XE Specification and Price Guide or configure your vehicle at jaguar.com

KEY OPTIONAL FEATURES

		PURE	PRESTIGE	PORTFOLIO	R-SPORT	S	
DYNAMIC FEATURES							
Six-Speed manual transmission with Optimal Shift Indicator (only available on 2.0L diesel engines)	—	●	●	●	●	—	Refer to page 23
Eight-Speed automatic transmission with Jaguar Sequential Shift, gear shift change paddles and All Surface Progress Control	—	○	○	○	○	●	Refer to page 22
Adaptive Dynamics (includes Configurable Dynamics when 3.0L 340PS petrol or 2.0L 180PS diesel engine with automatic transmission is selected) (NA 163PS)	C35A	—	○	○	○	●	
Adaptive Cruise Control with Queue Assist (requires automatic transmission)	H41F	○	○	○	○	○	
Adaptive Surface Response (requires AWD, automatic transmission and Adaptive Dynamics)	B73F	—	○	○	○	○	Refer to page 35

EXTERIOR FEATURES AND FINISHERS

EXTERIOR FEATURES AND TRIM							
Sliding Panoramic roof	F45C	○	○	○	○	○	
Powered boot lid	B69B	○	○	○	○	○	
Black radiator grille with Chrome surround		●	●	—	—	—	
Gloss Black radiator grille with Chrome surround		—	—	●	—	—	
Black radiator grille with Satin Chrome surround		—	—	—	●	—	
Gloss Black radiator grille with Satin Chrome surround		—	—	—	—	●	
Chrome radiator grille with Chrome surround	G12V	—	—	○	—	—	
Gloss Black radiator grille with Gloss Black surround	G12T	—	■	■	■	■	Part of Black Pack
Chrome side window surround with Black waist finisher		●	—	—	—	—	
Chrome side window surround	D53C	—	●	●	○	○	
Gloss Black side window surround	D53B	—	■	■	●	●	Part of Black Pack
R-Sport body kit	—	—	—	—	●	—	Includes R-Sport front bumper, body coloured extended side sills and boot lid mounted spoiler, Satin Chrome side power vents with R-Sport badge
S body kit	—	—	—	—	—	●	Includes S front bumper, Gloss Black extended side sills and rear valence, body coloured boot lid mounted spoiler, Satin Chrome side power vents
Red Brake Calipers with 'Jaguar' script	—	—	—	—	—	●	
Delete Powertrain badging	B05H	○	○	○	○	—	Removes engine badging

2 CHOOSE YOUR OPTIONS

 Configure your vehicle at jaguar.com

EXTERIOR FEATURES AND FINISHERS CONTINUED

		PURE	PRESTIGE	PORTFOLIO	R-SPORT	S	
GLASS AND EXTERIOR MIRRORS							DESCRIPTION
Power Fold, Auto-Dimming, Heated door mirrors with Approach Lights (requires Interior auto-dimming mirror)	B28P	○	○	○	○	○	
Infrared Reflective windscreen (front screen only)	D97B	○	○	○	○	○	This windscreen reflects infrared rays, keeping XE's interior cooler
Heated front windscreen with heated washer jets	D96A	○	○	○	○	○	
Rain sensing windscreen wipers (includes Automatic light sensing headlights)	D42R	○	○	○	○	●	
Privacy glass	H75A	○	○	○	○	○	
HEADLIGHTS AND LIGHTING							
Halogen headlights with Daytime Running Lights	D90V	●	●	—	●	—	
Bi-function Xenon headlights with LED 'J' blade Daytime Running Lights (includes Headlight Powerwash)	D90L	○	○	●	○	●	
Adaptive Bi-function Xenon headlights with LED 'J' blade Daytime Running Lights (includes Headlight Powerwash and Auto High Beam Assist) (requires rain sensing windscreen wipers)	D90K	■	■	■	■	■	
TOWING							
Detachable tow bar	C05C	○	○	○	○	—	
Electrically deployable tow bar	C05B	○	○	○	○	—	
EXTERIOR COLOURS							(Please see pages 66-67 for full colour palette)
Solid paint	—	●	●	●	●	●	Refer to page 66
Metallic paint	—	○	○	○	○	○	Refer to page 66-67
Premium paint	—	○	○	○	○	○	Refer to page 67
WHEELS							
Tyre Pressure Monitoring System	C42R	●	●	●	●	●	
Jaguar Tyre Repair System	C69A	●	●	●	●	●	
Space saver spare wheel (18") (replaces Jaguar Tyre Repair System)	C40D	○	○	○	○	○	

● Standard ○ Option — Not available ■ Option as part of Pack

Please consult your local Jaguar retailer for details.

For a complete list of optional features and packs refer to the XE Specification and Price Guide or configure your vehicle at jaguar.com

SEATING AND VENEERS

		PURE	PRESTIGE	PORTFOLIO	R-SPORT	S	
SEATING		CODE					DESCRIPTION
Heated front seats	F53A	○	○	○	○	○	
Heated front and rear seats	F53B	—	○	○	○	○	
Climate front seats with Heated rear seats (requires perforated leather, electric with lumbar seats)	F53C	—	○	○	○	○	Heated and cooled front seats with heated rear seats
8-Way manual front seat with electric recline	H53M	●	●	—	●	—	
10-Way electric front seats with manual headrest height	H53J	○	○	●	○	●	
4-Way electric lumbar adjust (only available with 10-way seats)	F52A	○	○	○	○	○	
14-Way electric front seats with 4-Way electric lumbar adjust	H53K	—	—	○	○	○	
Driver Memory (requires electric seats)	H44N	■	■	■	■	■	Adjusts driver seat, mirrors and steering column
Rear armrest with twin cupholders	H51A	○	●	●	●	●	
40:20:40 split fold rear seat with rear armrest	H48W	○	○	○	○	○	

VENEERS

Please see pages 86-87 for full range of veneers

HEADLINING AND INTERIOR FEATURES

HEADLINING

Light Oyster headlining	HAMT	●	●	●	○	○
Jet headlining	HPDB	○	○	○	●	●

INTERIOR FEATURES

Treadplates with Jaguar script	F28C	●	—	—	—	—
Metal treadplates with Jaguar script	F28E	—	●	●	—	—
Metal treadplates with R-Sport branding	F28N	—	—	—	●	—
Metal treadplates with S branding	F28S	—	—	—	—	●
Illuminated metal treadplates with Jaguar script	F28F	—	○	○	○	○
Carpet mats	H69H	○	●	—	●	●
Premium carpet mats	H69J	○	○	●	○	○

2 CHOOSE YOUR OPTIONS

 Configure your vehicle at jaguar.com

HEADLINING AND INTERIOR FEATURES CONTINUED

		PURE	PRESTIGE	PORTFOLIO	R-SPORT	S	
INTERIOR FEATURES [CONTINUED]							DESCRIPTION
Bright Sport pedals	G48S	—	—	—	—	●	
Heated steering wheel	F97A	○	○	○	○	○	
Electrically adjustable steering column	D07J	■	■	■	■	■	
Auto-Dimming interior rear view mirror	B68B	○	○	○	○	●	
Cabin Pre-Heat via remote	H10F	○	○	○	○	○	
Air Quality Sensor	C89A	○	○	○	○	○	
Electric rear window sunblind	H76G	○	○	○	○	○	
Interior Mood Lighting	B65A	○	●	●	●	●	
Configurable Interior Mood Lighting with ten colours	B65B	—	○	○	○	○	
Smoker's Pack	A03B	○	○	○	○	○	Includes single ashtray and single cigar lighter
Two additional power sockets	D72B	○	○	○	○	○	Additional 12V power socket in rear centre console and boot
SAFETY AND SECURITY							
Rear Parking Aid	C11A	○	○	○	○	○	
Front Parking Aid (requires Rear Parking Aid)	C13A	○	○	○	○	○	
Rear View Camera (requires Front and Rear Parking Aids)	C14A	○	○	○	○	○	
Surround Camera System (requires power fold mirrors)	C14D	■	■	■	■	■	Refer to page 50
Park Assist (requires Front and Rear Parking Aids)	C18B	■	■	■	■	■	
360° Parking Aid (requires Front and Rear Parking Aids)	C17A	■	■	■	■	■	Parallel and Perpendicular Parking
Trailer Stability Control	—	●	●	●	●	—	Intervenes when the system detects sway or potentially dangerous movement to bring the trailer back under control
Garage door opener (HomeLink®, requires Auto-dimming Interior Rear View Mirror)	B39N	○	○	○	○	○	
Lane Keep Assist and Driver Condition Monitor	H72D	○	○	○	○	○	Refer to page 50
Blind Spot Monitor and Reverse Traffic Detection (requires power fold mirrors and Rear Parking Aid)	H71C	○	○	○	○	○	Refer to page 50
Traffic Sign Recognition and Adaptive Speed Limiter (requires Navigation)	A41B	○	○	○	○	○	Refer to page 50
Keyless Entry	F04B	○	○	○	○	○	
Remote control central locking with deadlocks and drive-away locking	—	●	●	●	●	●	

● Standard ○ Option — Not available ■ Option as part of Pack

Please consult your local Jaguar retailer for details.

For a complete list of optional features and packs refer to the XE Specification and Price Guide or configure your vehicle at jaguar.com

INFORMATION, COMMUNICATION AND ENTERTAINMENT

		PURE	PRESTIGE	PORTFOLIO	R-SPORT	S	
FEATURES ONLY AVAILABLE WITH INCONTROL TOUCH		CODE					DESCRIPTION
8 inch Touch-screen	—	●	●	●	●	●	Refer to page 46
5 inch Instrument Display with analogue dials	—	●	●	●	●	●	
Jaguar Sound System (80W)	B43T	●	●	●	●	●	
Meridian™ Sound System (380W)	B44V	○	○	○	○	○	
InControl Touch SD Navigation Pack	Z58X	■	■	■	■	■	Pack consists of InControl Touch (SD) Navigation, Voice Control, Traffic Sign Recognition and Adaptive Speed Limiter
InControl Connect Pro Pack	Z77F	○	○	○	○	○	Pack consists of InControl Apps, Remote Premium and Wi-Fi Hotspot
FEATURES ONLY AVAILABLE WITH OPTIONAL INCONTROL TOUCH PRO							
InControl Touch Pro Navigation Pack with Meridian™ Digital Sound System (380W)	Z58Y	○	○	○	○	○	
InControl Touch Pro Navigation Pack with Meridian™ Digital Surround Sound System (825W)	Z59I	○	○	○	○	○	
Digital TV Tuner	G61D	○	○	○	○	○	Refer to page 46
InControl Connect Pro Pack	Z77H	○	○	○	○	○	Refer to page 47
FEATURES ONLY AVAILABLE WITH INCONTROL TOUCH AND INCONTROL TOUCH PRO							
InControl Protect	D45D	●	●	●	●	●	Includes SOS Emergency Call, Jaguar Optimised Assistance and Remote Essentials smartphone app. Refer to page 43
InControl Secure	D44A	○	○	○	○	○	Stolen Vehicle Tracking via your smartphone app. Refer to page 43
InControl Apps	H57A	○	○	○	○	○	
Head-Up Display with Infrared Reflective Windscreen (requires rain sensing windscreen wipers)	G62A	○	○	○	○	○	Refer to page 41
DAB Radio	B51A	○	○	○	○	○	
OPTION PACKS							
Cold Climate Pack	Z88D	○	○	○	○	○	
Power Convenience Pack	Z19B	○	○	○	○	○	
Convenience Pack	Z28A	○	○	○	○	—	
Lighting Pack	Z37E	○	○	○	○	○	
Memory Pack (requires electric seats)	Z15X	○	○	○	○	○	
Memory Pack with Powerfold Mirrors (requires electric seats)	Z15Y	○	○	○	○	○	
Parking Pack	Z68S	○	○	○	○	○	
Advanced Park Assist Pack	Z68T	○	○	○	○	○	
Advanced Park Assist Pack with Surround Camera System (requires power fold mirrors)	Z68U	○	○	○	○	○	
Road Technology Pack (requires automatic transmission)	Z80S	—	○	○	○	○	
Black Pack	Z93L	—	○	○	○	○	
Advantage Pack	Z68V	○	○	—	○	—	
Winter Pack	Z88P	○	○	—	○	—	

3 CHOOSE YOUR COLOUR

 [Configure your vehicle at jaguar.com](https://www.jaguar.com)

SOLID

Polaris White

Ebony Black

METALLIC

Glacier White

Rhodium Silver

Quartzite

Ammonite Grey

Bluefire*

Caesium Blue**

Dark Sapphire

Odyssey Red



*Only available until Summer 2016
**Available from Summer 2016

PREMIUM PALETTE

Italian Racing Red British Racing Green Ultimate Black Gallium Silver** Ingot Tempest Grey Storm Grey Celestial Black* Black Cherry* Cosmic Black**



4 CHOOSE YOUR WHEELS

 Configure your vehicle at jaguar.com



17" AERODYNAMIC 10 SPOKE¹



17" LIGHTWEIGHT 15 SPOKE¹



17" TURBINE 10 SPOKE²



17" CRUX 7 TWIN SPOKE²

ALLOY WHEEL FINISH	Sparkle Silver	Sparkle Silver	Sparkle Silver	Sparkle Silver
ALLOY WHEEL/SIZE	6.5J x 17"	6.5J x 17"	7.0J x 17"	7.0J x 17"
TYRE SIZE	205/55 R17	205/55 R17	205/55 R17 225/50 R17	205/55 R17 225/50 R17
CODE	C53E	C53C	C52Y	C53B
Pure	<input type="radio"/>	<input checked="" type="radio"/>	<input checked="" type="radio"/>	<input type="radio"/>
Prestige	<input type="radio"/>	<input checked="" type="radio"/>	<input checked="" type="radio"/>	<input type="radio"/>
Portfolio	<input type="radio"/>	<input checked="" type="radio"/>	<input type="radio"/>	<input type="radio"/>
R-Sport	<input type="radio"/>	<input checked="" type="radio"/>	<input type="radio"/>	<input type="radio"/>
S	<input type="radio"/>	<input type="radio"/>	<input type="radio"/>	<input type="radio"/>



17" PROJECTOR 5 SPOKE²



18" ARM 6 SPOKE²



18" MATRIX 7 TWIN SPOKE²



18" MATRIX 7 TWIN SPOKE²

ALLOY WHEEL FINISH	Sparkle Silver	Sparkle Silver	Sparkle Silver	Black
ALLOY WHEEL/SIZE	7.0J x 17"	7.5J x 18"	7.5J x 18"	7.5J x 18"
TYRE SIZE	225/50 R17	225/45 R18	225/45 R18	225/45 R18
CODE	C53D	C52P	C52Q	C52S
Pure	<input type="radio"/>	<input type="radio"/>	<input type="radio"/>	<input type="radio"/>
Prestige	<input type="radio"/>	<input type="radio"/>	<input type="radio"/>	<input type="radio"/>
Portfolio	<input type="radio"/>	<input checked="" type="radio"/>	<input type="radio"/>	<input type="radio"/>
R-Sport	<input type="radio"/>	<input type="radio"/>	<input type="radio"/>	<input type="radio"/>
S	<input type="radio"/>	<input type="radio"/>	<input type="radio"/>	<input type="radio"/>

● Standard ○ Option — Not Applicable

¹Only available on models with 163PS diesel engine. ²Not available with 163PS diesel engine.

Standard and optional features may differ depending on market availability.



18" STAR
5 SPOKE²

Silver/Diamond Turned
7.5J x 18" | 8.5J x 18"

225/45 R18 | 245/40 R18

C52N



18" TEMPLAR
5 TWIN SPOKE²

Silver/Diamond Turned
7.5J x 18" | 8.5J x 18"

225/45 R18 | 245/40 R18

C52L



19" STAR
5 TWIN SPOKE²

Sparkle Silver
7.5J x 19" | 8.5J x 19"

225/40 R19 | 255/35 R19

C52T



19" RADIANCE
15 SPOKE²

Sparkle Silver
7.5J x 19" | 8.5J x 19"

225/40 R19 | 255/35 R19

C52U

ALLOY WHEEL FINISH	Silver/Diamond Turned	Silver/Diamond Turned	Sparkle Silver	Sparkle Silver
ALLOY WHEEL/SIZE	7.5J x 18" 8.5J x 18"	7.5J x 18" 8.5J x 18"	7.5J x 19" 8.5J x 19"	7.5J x 19" 8.5J x 19"
TYRE SIZE	225/45 R18 245/40 R18	225/45 R18 245/40 R18	225/40 R19 255/35 R19	225/40 R19 255/35 R19
CODE	C52N	C52L	C52T	C52U
Pure	<input type="radio"/>	<input type="radio"/>	<input type="radio"/>	<input type="radio"/>
Prestige	<input type="radio"/>	<input type="radio"/>	<input type="radio"/>	<input type="radio"/>
Portfolio	<input type="radio"/>	<input type="radio"/>	<input type="radio"/>	<input type="radio"/>
R-Sport	<input checked="" type="radio"/>	<input type="radio"/>	<input type="radio"/>	<input type="radio"/>
S	<input type="radio"/>	<input checked="" type="radio"/>	<input type="radio"/>	<input type="radio"/>



19" RADIANCE
15 SPOKE²

Black/Diamond Turned
7.5J x 19" | 8.5J x 19"

225/40 R19 | 255/35 R19

C52M



19" VENOM
5 TWIN SPOKE²

Silver/Diamond Turned
7.5J x 19" | 8.5J x 19"

225/40 R19 | 255/35 R19

C52V



19" VENOM
5 TWIN SPOKE²

Black
7.5J x 19" | 8.5J x 19"

225/40 R19 | 255/35 R19

C52W



20" PROPELLER
10 SPOKE

Silver/Diamond Turned
8J x 20" | 9J x 20"

235/35 R20 | 265/30 R20

C52K

ALLOY WHEEL FINISH	Black/Diamond Turned	Silver/Diamond Turned	Black	Silver/Diamond Turned
ALLOY WHEEL/SIZE	7.5J x 19" 8.5J x 19"	7.5J x 19" 8.5J x 19"	7.5J x 19" 8.5J x 19"	8J x 20" 9J x 20"
TYRE SIZE	225/40 R19 255/35 R19	225/40 R19 255/35 R19	225/40 R19 255/35 R19	235/35 R20 265/30 R20
CODE	C52M	C52V	C52W	C52K
Pure	<input type="radio"/>	<input type="radio"/>	<input type="radio"/>	—
Prestige	<input type="radio"/>	<input type="radio"/>	<input type="radio"/>	—
Portfolio	<input type="radio"/>	<input type="radio"/>	<input type="radio"/>	—
R-Sport	<input type="radio"/>	<input type="radio"/>	<input type="radio"/>	—
S	<input type="radio"/>	<input type="radio"/>	<input type="radio"/>	<input type="radio"/>

5 CHOOSE YOUR INTERIOR

 Configure your vehicle at jaguar.com

PURE						
	SEAT	UPPER FACIA	INTERIOR TRIM AND OPTION CODES	HEADLINING MORZINE*	CARPET	FINISHER
Standard						
Premium cloth seats	Jet	Jet	TR01	Light Oyster	Jet	Gloss Black
	Latte	Jet	TR02	Light Oyster	Jet	Gloss Black
	Pebble Grey	Oyster	TR03	Light Oyster	Oyster	Gloss Black
PRESTIGE						
	SEAT WITH CONTRAST STITCH	FACIA UPPER/LOWER	INTERIOR TRIM AND OPTION CODES	HEADLINING	CARPET	FINISHER**
Standard						
Taurus Leather seats	Latte with Jet	Jet with Latte	TR06	Light Oyster	Jet	Brushed Aluminium
	Jet with Siena Tan	Jet with Jet	TR05	Light Oyster	Jet	Brushed Aluminium
	Light Oyster with Pistachio	Oyster with Light Oyster	TR07	Light Oyster	Oyster	Brushed Aluminium
PORTFOLIO						
	SEAT WITH TONAL STITCH	UPPER FACIA WITH TONAL STITCH	INTERIOR TRIM AND OPTION CODES	HEADLINING	CARPET	FINISHER**
Standard						
Perforated Windsor Leather seats	Brogue with Brogue	Jet with Jet/Brogue	TR19	Light Oyster	Jet	Embossed Aluminium
	Siena Tan with Siena Tan	Jet with Jet/Siena Tan	TR18	Light Oyster	Jet	Embossed Aluminium
	Jet with Jet	Jet with Jet/Jet	TR17	Light Oyster	Jet	Embossed Aluminium
	Light Oyster with Light Oyster	Oyster with Oyster/Light Oyster	TR20	Light Oyster	Oyster	Embossed Aluminium

*Jet Morzine headlining available as a cost option.

**Console finisher is Gloss Black.

†Light Oyster Morzine headlining available as a cost option.

R-SPORT						
	SEAT WITH CONTRAST STITCH	FACIA	INTERIOR TRIM AND OPTION CODES	HEADLINING†	CARPET	FINISHER**
Standard						
Luxtec and Technical Mesh Sport seats	Jet/Midnight Blue with Midnight Blue	Jet	TR11	Jet	Jet	Etched Aluminium
	Jet/Red with Red	Jet	TR09	Jet	Jet	Etched Aluminium
	Jet/Jet with Light Oyster	Jet	TR08	Jet	Jet	Etched Aluminium
Optional						
Perforated Taurus Leather Sport seats	Jet/Jet with Light Oyster	Jet with Light Oyster	TR63	Jet	Jet	Etched Aluminium
	Jet/Red with Red	Jet with Red	TR10	Jet	Jet	Etched Aluminium
	Jet/Midnight Blue with Midnight Blue	Jet with Midnight Blue	TR12	Jet	Jet	Etched Aluminium
	Jet/Light Oyster with Light Oyster	Jet with Light Oyster	TR13	Jet	Jet	Etched Aluminium
S						
	DUOTONE SEAT WITH CONTRAST STITCH	FACIA WITH CONTRAST STITCH	INTERIOR TRIM AND OPTION CODES	HEADLINING	CARPET	FINISHER**
Standard						
Taurus Leather and Suedecloth Sport seats	Red/Jet with Jet	Jet with Red	TR14	Jet	Jet	Meshed Aluminium
	Jet/Jet with Light Oyster	Jet with Light Oyster	TR21	Jet	Jet	Meshed Aluminium
	Midnight Blue/Jet with Jet	Jet with Midnight Blue	TR15	Jet	Jet	Meshed Aluminium
	Light Oyster/Jet with Jet	Jet with Light Oyster	TR16	Jet	Jet	Meshed Aluminium
Optional						
Perforated Taurus Leather Sport seats	Jet/Jet with Light Oyster	Jet with Light Oyster	TR21	Jet	Jet	Meshed Aluminium
	Red/Jet with Jet	Jet with Red	TR14	Jet	Jet	Meshed Aluminium
	Midnight Blue/Jet with Jet	Jet with Midnight Blue	TR15	Jet	Jet	Meshed Aluminium
	Light Oyster/Jet with Jet	Jet with Light Oyster	TR16	Jet	Jet	Meshed Aluminium

5 CHOOSE YOUR INTERIOR

⚙️ Configure your vehicle at [jaguar.com](https://www.jaguar.com)

Interior shown: Jet cloth seats with Gloss Black finisher, Light Oyster headlining and Jet facia.



PURE

INTERIOR COLOUR COMBINATIONS

STANDARD

1

SEAT



Jet

2

FINISHER



Gloss Black

3

HEADLINING



Light Oyster

4

FACIA



Jet

5

CARPET



Jet



Latte



Gloss Black



Light Oyster



Jet



Jet



Pebble Grey



Gloss Black



Light Oyster

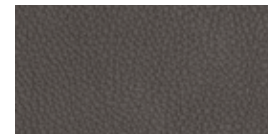

Oyster



Oyster

OPTIONS

HEADLINING

Jet

FINISHER

—

5 CHOOSE YOUR INTERIOR

⚙️ Configure your vehicle at [jaguar.com](https://www.jaguar.com)













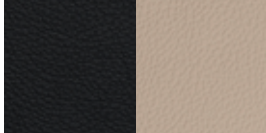

Interior shown: Latte Leather seats with Jet contrast stitch, Brushed Aluminium finisher, Light Oyster headlining, Jet upper fascia and Latte lower fascia.



PRESTIGE

INTERIOR COLOUR COMBINATIONS

STANDARD

1	2	3	4	5
SEAT WITH CONTRAST STITCH	FINISHER*	HEADLINING	FACIA UPPER/LOWER	CARPET
				
Latte with Jet	Brushed Aluminium	Light Oyster	Jet with Latte	Jet
				
Jet with Siena Tan	Brushed Aluminium	Light Oyster	Jet with Jet	Jet
				
Light Oyster with Pistachio	Brushed Aluminium	Light Oyster	Oyster with Light Oyster	Oyster

OPTIONS

HEADLINING	FINISHER
Jet	Satin Burr Ash, Gloss Figured Ebony, Satin Grey Ash, Satin Grey Figured Ebony, Satin Fine Line Wood or Carbon Fibre

*Console finisher is Gloss Black.

5 CHOOSE YOUR INTERIOR

⚙️ Configure your vehicle at [jaguar.com](https://www.jaguar.com)













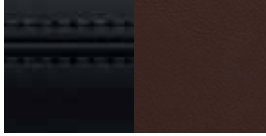

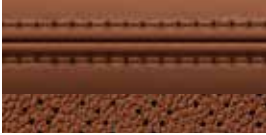

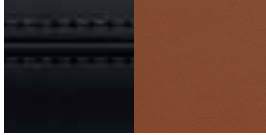
Interior shown: Brogue Leather seats with Herringbone perforations and Brogue tonal stitch. Embossed Aluminium finisher, Light Oyster headlining, Jet upper fascia and Brogue lower fascia.

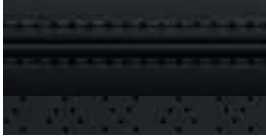

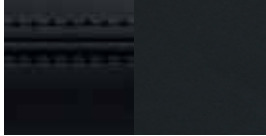
PORTFOLIO

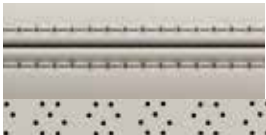
INTERIOR COLOUR COMBINATIONS

STANDARD

1	2	3	4	5
SEAT WITH TONAL STITCH	FINISHER*	HEADLINING	FACIA UPPER WITH TONAL STITCH/LOWER	CARPET
				
Brogue with Brogue	Embossed Aluminium	Light Oyster	Jet with Jet/Brogue	Jet
				
Siena Tan with Siena Tan	Embossed Aluminium	Light Oyster	Jet with Jet/Siena Tan	Jet
				
Jet with Jet	Embossed Aluminium	Light Oyster	Jet with Jet	Jet
				
Light Oyster with Light Oyster	Embossed Aluminium	Light Oyster	Oyster with Oyster/Light Oyster	Oyster

OPTIONS

HEADLINING

Jet

FINISHER

Satin Burr Ash, Gloss Figured Ebony, Satin Grey Ash, Satin Grey Figured Ebony, Satin Fine Line Wood or Carbon Fibre

*Console finisher is Gloss Black.

5 CHOOSE YOUR INTERIOR

⚙️ Configure your vehicle at [jaguar.com](https://www.jaguar.com)















Interior shown: Jet Luxtec Sport seats with technical mesh inserts and Midnight Blue contrast stitch. Etched Aluminium finisher, Jet headlining and Jet facia.



R-SPORT

INTERIOR COLOUR COMBINATIONS

STANDARD

1	2	3	4	5
SEAT WITH CONTRAST STITCH	FINISHER*	HEADLINING	FACIA	CARPET
				
Jet/Midnight Blue with Midnight Blue	Etched Aluminium	Jet	Jet	Jet
				
Jet/Red with Red	Etched Aluminium	Jet	Jet	Jet
				
Jet/Jet with Light Oyster	Etched Aluminium	Jet	Jet	Jet

OPTIONS

HEADLINING	FINISHER
Light Oyster	Satin Burr Ash, Gloss Figured Ebony, Satin Grey Ash, Satin Grey Figured Ebony, Satin Fine Line Wood and Carbon Fibre

*Console finisher is Gloss Black.

5 CHOOSE YOUR INTERIOR

⚙️ Configure your vehicle at jaguar.com















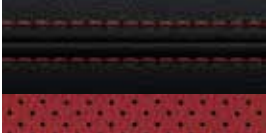

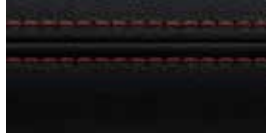

Interior shown: Jet Perforated Leather Sport seats with Light Oyster contrast stitch. Etched Aluminium finisher, Jet headlining and Jet facia with Light Oyster contrast stitch.



R-SPORT

INTERIOR COLOUR COMBINATIONS

OPTIONS

1	2	3	4	5
SEAT WITH CONTRAST STITCH	FINISHER*	HEADLINING	FACIA	CARPET
 Jet/Jet with Light Oyster	 Etched Aluminium	 Jet	 Jet with Light Oyster	 Jet
 Jet/Red with Red	 Etched Aluminium	 Jet	 Jet with Red	 Jet
 Jet/Midnight Blue with Midnight Blue	 Etched Aluminium	 Jet	 Jet with Midnight Blue	 Jet
 Jet/Light Oyster with Light Oyster	 Etched Aluminium	 Jet	 Jet with Light Oyster	 Jet

OPTIONS

HEADLINING	FINISHER
Light Oyster	Satin Burr Ash, Gloss Figured Ebony, Satin Grey Ash, Satin Grey Figured Ebony, Satin Fine Line Wood or Carbon Fibre

*Console finisher is Gloss Black.

5 CHOOSE YOUR INTERIOR

⚙️ Configure your vehicle at jaguar.com

Interior shown: Red Leather Sport seats with Jet Suedecloth inserts and Jet contrast stitch. Meshed Aluminium finisher, Jet headlining and Jet fascia with Red contrast stitch.



1

3

2











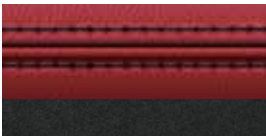



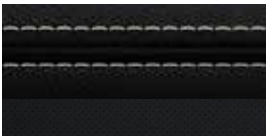

4

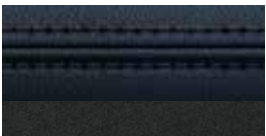
5

S

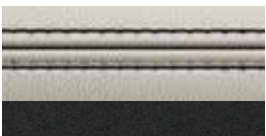
INTERIOR COLOUR COMBINATIONS

STANDARD

1	2	3	4	5
DUOTONE SEAT WITH CONTRAST STITCH	FINISHER*	HEADLINING	FACIA WITH CONTRAST STITCH	CARPETS
 Red/Jet with Jet	 Meshed Aluminium	 Jet	 Jet with Red	 Jet
 Jet/Jet with Light Oyster	 Meshed Aluminium	 Jet	 Jet with Light Oyster	 Jet
 Midnight Blue/Jet with Jet	 Meshed Aluminium	 Jet	 Jet with Midnight Blue	 Jet
 Light Oyster/Jet with Jet	 Meshed Aluminium	 Jet	 Jet with Light Oyster	 Jet

OPTIONS

HEADLINING	FINISHER
Light Oyster	Satin Burr Ash, Gloss Figured Ebony, Satin Grey Ash, Satin Grey Figured Ebony, Satin Fine Line Wood or Carbon Fibre

*Console finisher is Gloss Black.

5 CHOOSE YOUR INTERIOR

⚙️ Configure your vehicle at [jaguar.com](https://www.jaguar.com)



















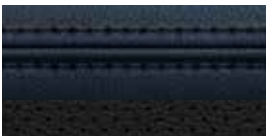

Interior shown: Jet Perforated Leather seats with Light Oyster contrast stich. Meshed Aluminium finisher, Jet headlining and Jet fascia with Light Oyster contrast stich.



S

INTERIOR COLOUR COMBINATIONS

OPTIONS

1	2	3	4	5
DUOTONE SEAT WITH CONTRAST STITCH	FINISHER*	HEADLINING	FACIA WITH CONTRAST STITCH	CARPET
 Jet/Jet with Light Oyster	 Meshed Aluminium	 Jet	 Jet with Light Oyster	 Jet
 Red/Jet with Jet	 Meshed Aluminium	 Jet	 Jet with Red	 Jet
 Midnight Blue/Jet with Jet	 Meshed Aluminium	 Jet	 Jet with Midnight Blue	 Jet
 Light Oyster/Jet with Jet	 Meshed Aluminium	 Jet	 Jet with Light Oyster	 Jet

OPTIONS

HEADLINING	FINISHER
Light Oyster	Satin Burr Ash, Gloss Figured Ebony, Satin Grey Ash, Satin Grey Figured Ebony, Satin Fine Line Wood or Carbon Fibre

*Console finisher is Gloss Black.

5 CHOOSE YOUR INTERIOR

 Configure your vehicle at jaguar.com

Gloss Black

Dark Satin Brushed Aluminium

Embossed Aluminium

Etched Aluminium

Meshed Aluminium

Carbon Fibre

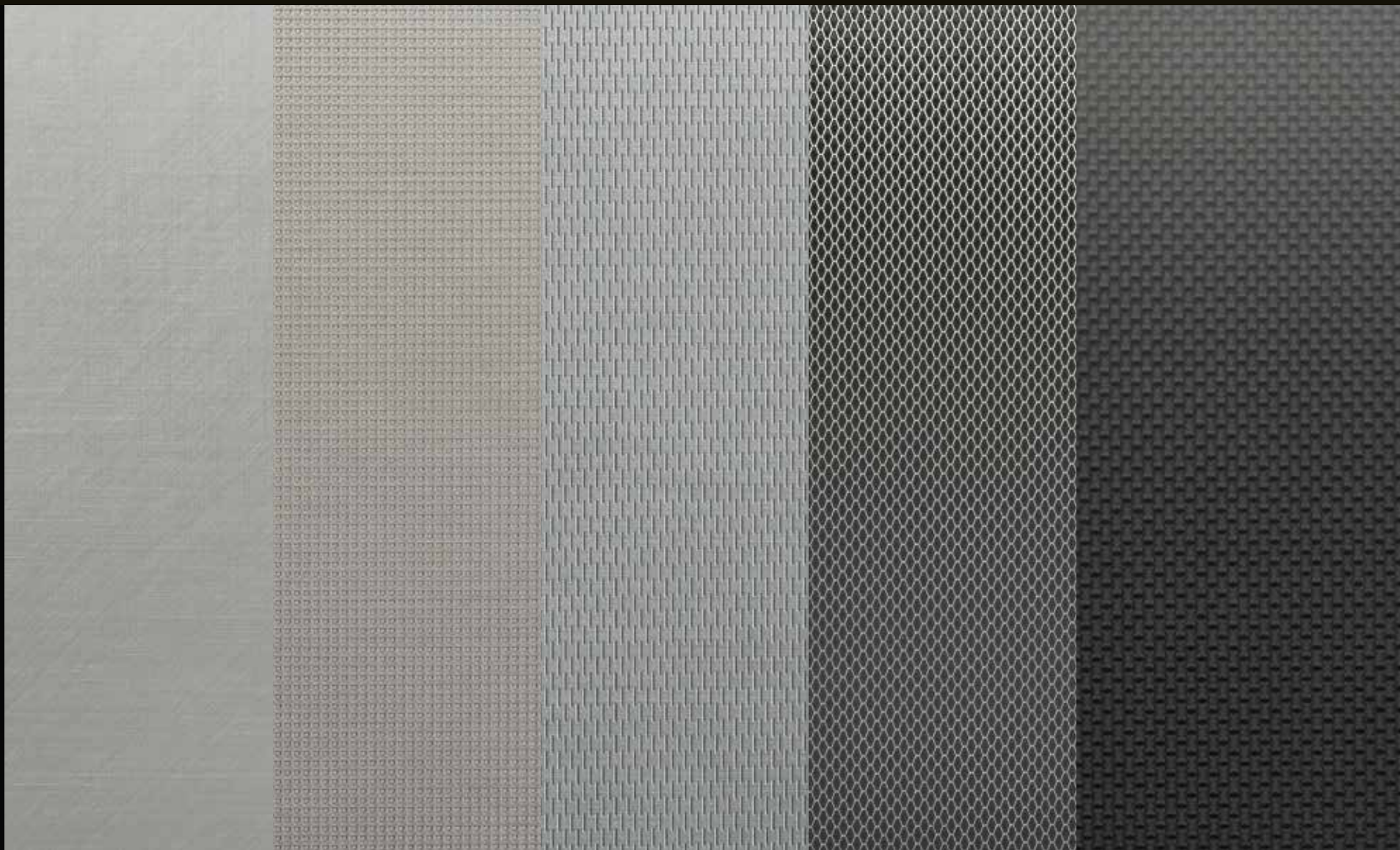

Satin Ash Burr



Gloss Figured Ebony



Satin Grey Ash



Satin Grey Figured Ebony



Satin Fine Line Wood



6 CHOOSE YOUR JAGUAR ACCESSORIES

To find out more about the full range of retailer fit Jaguar Accessories, please refer to your retailer or go to accessories.jaguar.com



Roof Mounted Cycle Carrier* **C2A1539**

An easy to fit, roof mounted, lockable cycle carrier which carries one bike per holder. A maximum of three holders can be fitted.

*Requires Roof Cross Bars T4N4709. **Not available on Pure. †Automatic only. ‡Offered for models fitted with space saver spare wheel only.
VEHICLE SHOWN: XE S IN ITALIAN RACING RED WITH OPTIONAL FEATURES FITTED (MARKET DEPENDENT)



Personalised Illuminated Sill Treadplates**
T4N7511

Elegantly styled stainless steel sill treadplate finishers for driver or passenger doors. Illuminates when either the driver or passenger doors are opened. Highlighted by soft Phosphor Blue lighting. Allows customer to specify a monochrome 'motif' in a choice of approved typefaces/scripts.



Aluminium Gearshift Paddles†
T2R6547MMU

Replacement steering wheel gearshift paddles offered in a premium aluminium material providing a high quality finish to a key contact point in the vehicle. Manufactured from billet machined aluminium, the paddles are hand brushed for a premium finish and anodised to ensure they will not deteriorate with wear.



iPad® Holder
T2H7757

Jaguar branded iPad® holder mounts to front seat headrests providing a flexible solution for rear seat entertainment. Quick release design ensures iPad® can be fitted or removed quickly and easily.



Sport Pedal Covers
T2H3747 - Manual Transmission Vehicles
T2H3746 - Automatic Transmission Vehicles (not shown)

Made from stainless steel and rubber, the pedal kit fits securely over existing pedals for a contemporary, sporting appearance.



Premium Carpet Mats
T4N7146 PVJ - Jet
T4N7146 AMT - Oyster

Luxurious, tailored 2,050g/m² pile front carpet mats with embossed Jaguar logo and nubuck edge binding. The premium mats provide a well appointed finishing touch to the interior.



Premium Luggage Compartment Carpet Mat†
T4N7147PVJ

Luxurious soft luggage mat in Jet Black with the Jaguar logo. Deep premium 2,050g/m² pile with nubuck edging and Dove contrast stitch.

6 CHOOSE YOUR JAGUAR ACCESSORIES

 Configure your vehicle at jaguar.com



Gloss Black Side Power Vent
T4N5176 - Left Side
T4N5178 - Right Side

Gloss Black side power vents provide a dynamic exterior styling enhancement.



Carbon Fibre Side Power Vent
T2H6208 - Left Side
T2H6209 - Right Side

High grade Carbon Fibre side power vents provide a performance-inspired styling upgrade.



Chrome Grille*
T4N3033

Provides a Chrome finish to the grille surround and bumper beam accentuating the XE's luxury appearance.



Gloss Black Mirror Cover
C2D6066PEC - Left Side
C2D6067PEC - Right Side

Gloss Black mirror covers accentuate the dynamic design of the exterior mirrors.



Carbon Fibre Mirror Cover
C2P24176 - Left Side
C2P24177 - Right Side

High grade Carbon Fibre mirror covers provide a performance-inspired styling upgrade.



Chrome Mirror Cover
C2D5489 - Left Side
C2D5488 - Right Side

Chrome mirror covers accentuate the stylish design of the exterior mirrors.

*Standard on Portfolio. **Requires roof cross bars T4N4709. †For Pure, Prestige and Portfolio.



Roof Cross Bars
T4N4709

Jaguar branded cross bars required for fitting all roof carrying equipment. Engineered specifically for your vehicle.



Watersports Carrier**
C2Z21730

A versatile system for transporting a variety of water sports equipment including surfboard, kayak or sailboard. Tilts to facilitate loading/unloading.



Roof Sport Box**
C2C41627

Spacious 320 litre capacity lockable roof box designed for sports equipment, measuring 206 x 84 x 34cm.



Chrome Front Splitter†
T4N7599

Give XE an even more stylish look with this bright finish front splitter blade. Body coloured rear spoiler is also available. (T4N5462LML)



Rear Splash Guards
T4N7514

Jaguar branded, rear splash guards complement the lines of your vehicle and provide protection from dirt and stone chippings.



Tow Bar Mounted Cycle Carrier
C2Z22695 - Two Bike Carrier
C2Z22697 - Three Bike Carrier

Premium tow ball mounted cycle carriers provide a convenient bike carrying solution with quick release loading attachments and secure locking mechanism. Clever design allows carrier to be tilted away from vehicle when fitted allowing access into the rear tailgate.

TECHNICAL SPECIFICATIONS

 Configure your vehicle at jaguar.com

ENGINES		2.0 LITRE 163 4-CYLINDER TURBOCHARGED E-PERFORMANCE DIESEL [RWD]	2.0 LITRE 180 4-CYLINDER TURBOCHARGED DIESEL [RWD]	2.0 LITRE 180 4-CYLINDER TURBOCHARGED DIESEL [AWD]		
Capacity	cc	1,999	1,999	1,999		
Maximum power	EEC-PS (kW)	163 (120)	180 (132)	180 (132)		
@rev/min	rpm	4,000	4,000	4,000		
Maximum torque	EEC-Nm (lb.ft.)	380 (280)	430 (318)	430 (318)		
@rev/min	rpm	1,750-2,500	1,750-2,500	1,750-2,500		
PERFORMANCE		MANUAL	AUTOMATIC	MANUAL	AUTOMATIC	AUTOMATIC
0-100 km/h	seconds	8.4	8.2	7.8	7.8	7.9
0-60 mph	seconds	7.9	7.7	7.4	7.4	7.5
Top speed	km/h (mph)	227 (141)	227 (141)	231 (144)	228 (142)	225 (140)
FUEL CONSUMPTION ¹		MANUAL	AUTOMATIC	MANUAL	AUTOMATIC	AUTOMATIC
Urban	l/100km (mpg)	4.4 (64.2)	5.0 (56.5)	5.0 (56.5)	5.0-5.1 (55.4-56.5)	5.5 (51.4)
Extra Urban	l/100km (mpg)	3.4 (83.1)	3.5 (80.7)	3.7 (76.4)	3.7 (76.4)	4.2 (67.8)
Combined	l/100km (mpg)	3.8 (75.0)	4.1 (68.9)	4.2 (67.3)	4.2 (67.3)	4.7 (60.6)
Carbon dioxide emissions	g/km	99	106	109	109-111	123
Tank capacity (usable)	ltr approx.	47	47	56	56	56
DIMENSIONS						
Overall length	mm	4,672		4,672		4,672
Overall width (inc. mirrors)	mm	2,075		2,075		2,075
Overall width (exc. mirrors)	mm	1,850		1,850		1,850
Overall height	mm	1,416		1,416		1,425
Wheelbase	mm	2,835		2,835		2,835
Front track	mm	1,607		1,597-1,604		1,597-1,604
Rear track	mm	1,608		1,585-1,598		1,585-1,598
Ground clearance	mm	110		110		119
Turning circle diameter (kerb to kerb)	m	11.7		11.7		11.7
Boot volume	litres	455		455		455
WEIGHT ²		MANUAL	AUTOMATIC	MANUAL	AUTOMATIC	AUTOMATIC
Weight from	kg	1,435	1,450	1,490	1,505	1,615
Gross vehicle weight	kg	2,100	2,100	2,135	2,135	2,230
ENGINE AVAILABILITY						
Pure		●		●		●
Prestige		●		●		●
Portfolio		●		●		●
R-Sport		●		●		●
S		—		—		—

● Available — Not Available

¹The figures provided are as a result of official manufacturer's tests in accordance with EU legislation. A vehicle's actual fuel consumption may differ from that achieved in such tests and these figures are for comparative purposes only.

²Weights reflect vehicles to standard specifications. Optional extras increase weight.

ENGINES		2.0 LITRE 200 4-CYLINDER TURBOCHARGED PETROL [RWD]	2.0 LITRE 240 4-CYLINDER TURBOCHARGED PETROL [RWD]	3.0 LITRE V6 340 SUPERCHARGED PETROL [RWD]
Capacity	cc	1,999	1,999	2,995
Maximum power	EEC-PS (kW)	200 (147)	240 (177)	340 (250)
@rev/min	rpm	5,500	5,500	6,500
Maximum torque	EEC-Nm (lb.ft.)	320 (236)	340 (251)	450 (332)
@rev/min	rpm	1,750-4,000	1,750-4,000	4,500
PERFORMANCE		RWD	RWD	RWD
0-100 km/h	seconds	7.7	6.8	5.1
0-60 mph	seconds	7.1	6.5	4.9
Top speed	km/h (mph)	237 (147)	250 (155)	250 (155)
FUEL CONSUMPTION ¹		RWD	RWD	RWD
Urban	l/100km (mpg)	10.2 (27.7)	10.2 (27.7)	11.6 (24.4)
Extra Urban	l/100km (mpg)	6.0 (47.1)	6.0 (47.1)	6.1 (46.3)
Combined	l/100km (mpg)	7.5 (37.7)	7.5 (37.7)	8.1 (34.9)
Carbon dioxide emissions	g/km	179	179	194
Tank capacity (usable)	ltr approx.	63	63	63
DIMENSIONS		RWD	RWD	RWD
Overall length	mm	4,672	4,672	4,672
Overall width (inc. mirrors)	mm	2,075	2,075	2,075
Overall width (exc. mirrors)	mm	1,850	1,850	1,850
Overall height	mm	1,416	1,416	1,416
Wheelbase	mm	2,835	2,835	2,835
Front track	mm	1,597-1,604	1,597-1,604	1,596-1,602
Rear track	mm	1,585-1,598	1,585-1,598	1,597-1,603
Ground clearance	mm	110	110	110
Turning circle diameter (kerb to kerb)	m	11.7	11.7	11.7
Boot volume	litres	455	455	455
WEIGHT ²		RWD	RWD	RWD
Weight from	kg	1,515	1,520	1,635
Gross vehicle weight	kg	2,120	2,120	2,220
ENGINE AVAILABILITY		RWD	RWD	RWD
Pure		●	●	—
Prestige		●	●	—
Portfolio		●	●	—
R-Sport		●	●	—
S		—	—	●

DIMENSIONS

Overall Width (inc mirrors) 2,075mm

Overall Width (exc mirrors) 1,850mm

Boot Volume 455 Litres



Turning Circle
Kerb to Kerb 11.7m



Dimensions were measured with vehicle at unladen weight.
(measured by VDA standard test method using 200 x 100 x 50mm blocks.)

JAGUAR EXPERIENCE

There's no better way to get to know Jaguar than by taking a drive. The Jaguar Experience offers a range of unique opportunities to really find out what it feels like to get the most out of a Jaguar. Our track experiences allow you to push yourself and cars from the incredible Jaguar range to the limit. Jaguar Experience also offers the opportunity to see a Jaguar brought to life during a tour of one of our UK manufacturing facilities.

Find out more by visiting jaguar.com/experience



BEHIND THE SCENES

Our factory tours give you the unique opportunity to experience the whole process of how our cars are brought to life - from the moulding of sheet metal to those intricate final touches. At our state-of-the-art production facilities, you'll get to see how skilled technicians and sophisticated machines work seamlessly together to perfect some of Jaguar's most breathtaking cars - from the powerful F-TYPE to the groundbreaking F-PACE performance SUV.

Find out more at jaguar.com/experience-jaguar/behind-the-scenes



DRIVING EXPERIENCES

The opportunity to drive the latest Jaguar cars at their limits, or relive iconic Jaguar history, is rare. Jaguar Driving Experiences offer unique driving adventures you will never forget. Imagine yourself behind the wheel of our highest performing Jaguar models, on a private track, with a Jaguar Experience Instructor at your side. This is the Jaguar Performance Driving Academy.

Find out more at [jaguar.com/experience-jaguar/driving-experiences](https://www.jaguar.com/experience-jaguar/driving-experiences)



ICONIC EXPERIENCES

Take your driving to the next level with our international adventures facing extreme road, and off-road, conditions. Our Iconic Experiences offer journeys and challenges that will test and develop your performance driving skills. Every year, Jaguar customers and enthusiasts join us for our luxury Ice Driving Experience. The exclusive ski resort in Gstaad, Switzerland, is the perfect location to enjoy the thrill of performance driving on ice. Our Ice Driving Experience is a two-day getaway held each winter. You can get a flavour of the event below. Then, if you'd like to be part of it in the next experience, we can keep you posted.

Find out more at [jaguar.com/experience-jaguar/iconic-experiences](https://www.jaguar.com/experience-jaguar/iconic-experiences)

THE WORLD OF JAGUAR

Choose an XE and you're joining the exciting World of Jaguar. It makes owning and driving carefree and easy, as well as providing a range of exclusive services and lifestyle products.



JAGUAR CARE*

What makes XE totally irresistible is that every new car comes with Jaguar Care, which includes an unlimited mileage, three year warranty and three years' free standard servicing. So however far you drive, your journeys will be worry free. To find out more about XE's superbly competitive Jaguar Care programme, please go to jaguar.com/jaguarcare



SERVICING

XE has been designed to keep servicing costs to a minimum - for example, the new Ingenium diesel engines can achieve an incredible 34,000km or 2 years** between services due to intelligent design and advanced oil technology.

GENUINE PARTS

Jaguar Genuine Parts are designed, tested and manufactured to our uncompromising standards for quality, fit and durability. Each part is engineered specifically for your XE to contribute to optimum performance and to help maximise its lifespan.



JAGUAR FINANCIAL SERVICES

Effortless performance and style come as standard with every Jaguar. Jaguar Financial Services makes buying one just as simple and rewarding. New or used, for personal or business use, we have an option that puts you in complete control. Please speak to your local Jaguar retailer to find out more.



JAGUAR ASSISTANCE

Jaguar Assistance provides assistance in motoring emergencies, from immobilisation due to breakdown or accident to minor problems such as punctures. You can rely on our roadside assistance, whatever the situation, wherever you happen to be.

LOW INSURANCE

XE's key components are easily accessible for time-efficient service and repair and to minimise scheduled maintenance and repair costs. With a focus on lower repair costs, XE delivers competitive insurance group ratings[†]. To find out more about the compelling business case for XE, please contact your local Jaguar retailer.



FLEET & BUSINESS

Jaguar is dedicated to being the premium manufacturer of choice for fleets and businesses by providing a highly attractive car range and exemplary customer service. Jaguars are dynamic and distinctive cars that help companies express the unique character and personality of their business. We are committed to providing totally customer-focused aftersales services, which keeps every Jaguar car on the move and in top condition, ensuring that they perform to the highest standard and in the most cost-efficient way for businesses. Visit jaguar.com/fleet-and-business



JAGUAR MAGAZINE

Jaguar Magazine is the official magazine of Jaguar Cars. It features the new Jaguar F-PACE, F-TYPE, XJ, XE and XF, and the worlds of luxury, style, design and travel.

JAGUAR COLLECTION

The latest range from the Jaguar Collection has been crafted with the same design execution and attention to detail that goes into all of our cars. This is evident in our clothing range, premium leather items and luxury travel goods. To celebrate Jaguar's heritage we also have a collection that honours past achievements and features race-inspired gift items and apparel. To find out more, visit the online shop at www.jaguar.com/shop

*Selected European Markets only.
**Market and driving style dependent.
†Manufacturer's estimate.

GLOSSARY

A

AUDIO EQUALISATION

Audio Equalisation lets you fine tune the sound of your car's audio system by giving you tone adjustment not covered by standard treble, mid-range, and bass controls.

C

Cd

The Cd value is the drag coefficient of the car. It gives an indication of the vehicle's aerodynamic qualities. The lower the value, the more aerodynamically efficient the vehicle's design.

D

DAMPERS/DAMPING

Dampers absorb forces acting on the suspension for greater ride comfort and control. Dampers are also known as shock absorbers.

DRAG COEFFICIENT

The drag coefficient measures how aerodynamic a car is. See definition of Cd.

DSP AMPLIFIER

Meridian's Digital Signal Processing (DSP) technology analyses a range of variables that may impact audio quality, then processes them using sophisticated algorithms and adapts the system's output accordingly. This enables a level of powerful, authentic performance impossible with a conventional sound system.

E

ECO MODE

Eco Mode encourages fuel efficient driving by reducing throttle sensitivity, selecting more economical engine mapping and, on manual vehicles, advising of gear shifts. It also reduces fuel consumption by reducing the energy demands placed on the engine by climate control and audio systems.

J

JAGUARDRIVE CONTROL

Interacts with the Dynamic Stability Control system, engine and transmission management systems to alter the characteristics of the engine mapping, gear shifts and brakes. It offers different modes designed to optimise the vehicle's response to particular driving conditions and styles.

'J' BLADE DAYTIME RUNNING LIGHTS

'J' blade Daytime Running Lights are separate LED running lights, in a distinctive 'J' shape, built into the headlights. They emphasise Jaguar's striking on road style.

JAGUARDRIVE SELECTOR

The JaguarDrive Selector rises from the centre console on start up. It is a rotary shifter used with automatic transmissions that allows you to quickly shift between drive modes.

M

MHL CONNECTION

A Mobile High-Definition Link (MHL) enables connection between a personal device and the InControl infotainment system. It is designed for seamless transfer of audio-visual data.

S

SUPERCHARGED PETROL

A petrol engine with a supercharger. A supercharger is a forced induction device mechanically driven by the engine. It offers higher power outputs and immediate, linear response at all engine speeds.

T

10.2 INCH MULTI-TOUCHSCREEN WITH MULTI-TOUCH GESTURES

The Multi-touch functionality of InControl Touch Pro's 10.2 inch Display allows the screen to recognise multiple points of contact. This provides direct control of the system's features in a more natural, intuitive way, enabling gestures such as pinch and zoom.

TURBOCHARGED DIESEL

Diesel engine with a turbocharger. A turbocharger is a forced induction device powered by exhaust gases. Turbocharging produces higher power outputs, lower emissions levels, and improved efficiency and refinement compared to similar capacity naturally aspirated engines.

X

XENON HEADLIGHTS

Bi-function Xenon headlights offer improved illumination and feature LED 'J' blade Daytime Running Lights for a striking on road style.



IMPORTANT NOTICE

Jaguar Land Rover Limited is constantly seeking ways to improve the specification, design and production of its vehicles and alterations take place continually. While every effort is made to produce up-to-date literature, this brochure should not be regarded as an infallible guide to current specifications, nor does it constitute an offer for the sale of any particular vehicle. Distributors and Retailers are not agents of Jaguar Land Rover Limited by any express or implied undertaking or representation. Comparisons are based on manufacturer's own data and testing prior to publication.

COLOURS

Print and online colours are representative only.

ENVIRONMENTAL INNOVATION AT JAGUAR

F-PACE, XF, XE, XJ and F-TYPE's innovative use of lightweight aluminium, which incorporates up to 50% closed-loop recycled material from the manufacturing process of the body structures, provides considerable performance benefits. This includes improved fuel consumption and less CO₂ emissions during the use phase of the Life Cycle due to lighter structures. Our on-going target is to ensure scrap aluminium reclaimed from our stamping process is to be segregated and recycled through a closed loop system and incorporated back into the same grade quality aluminium sheet, therefore reducing CO₂ emissions, versus the use of virgin aluminium sheets, during the production phase of the Life Cycle.

Jaguar is committed to reducing dependency on fossil fuels, using fewer natural resources and creating less waste as part of our approach to responsible and sustainable business development, called Environmental Innovation.

The company plan includes ongoing reduction in CO₂ emissions & the use of natural resources and at the end of 2014 we have achieved a 28% reduction in operating CO₂ emissions, 25% in the Company's European fleet average tailpipe emissions, 75% in waste to landfill, logistics efficiencies (18%) and water consumption (10%), all based on per vehicle built since 2007. In addition the manufacturing assembly CO₂ emissions of each Jaguar built in the UK since 2009, is 100% offset as part of our 2020 strategy for carbon neutral manufacturing assembly and since 2013 carbon-for-development projects form a key part of the company's Global Corporate Social Responsibility (CSR) programme.

For each tonne of CO₂ emitted in the assembly process, the company invests in emissions reductions projects that reduce an equivalent tonne of CO₂ elsewhere and provide social and humanitarian benefits at the same time. Since 2013 the programme has offset 800,000 tonnes of CO₂ and improved the lives of over 2 million people from our award winning Lifestraw carbon-for-water emissions reduction programme.

Taking into account the company's global sales growth and increased investment in more efficient operating facilities, we are proud to have delivered and in some cases exceeded our Environmental Innovation targets as planned between 2012-2015. But it doesn't stop there. Our manufacturing facilities have been certified to ISO14001 since 1998 and in 2013 the Company was recognised as the UK's Responsible Business of the Year by leading CR index, Business in the Community. In 2014 we built on this success through the Queens award for Enterprise in Sustainable Development for 2014.

Looking forward, we have developed our 2020 vision for sustainable business growth that focuses on continued improvements in operating & tailpipe CO₂ emissions, carbon neutral manufacturing and zero waste. The company will also improve the lives of 12 million people by 2020 as part of the global Corporate Social Responsibility programme

Meridian is the registered trademark of Meridian Audio Ltd.

AdBlue. is the registered trademark of the Verband der Automobilindustrie e. V. (VDA).

The Bluetooth. word mark and logos are owned by the Bluetooth SIG, Inc. and any use of such marks by Jaguar Land Rover Limited is under licence.

iPod, iPod touch and iPad are trademarks of Apple Inc, registered in the US and other countries.

The Navigation system must always be used in conditions that will not affect the driver's ability to drive safely or affect the safety of other road users

VEHICLE SHOWN FRONT COVER: XE S IN ITALIAN RACING RED WITH OPTIONAL FEATURES FITTED (MARKET DEPENDENT)

VEHICLE SHOWN BACK COVER: XE S IN GLACIER WHITE WITH OPTIONAL FEATURES FITTED (MARKET DEPENDENT)

Jaguar Land Rover Limited
Registered Office: Abbey Road, Whitley,
Coventry, CV3 4LF, United Kingdom
Registered in England Number: 1672070
jaguar.com



