

NEW RANGE ROVER VELAR



ABOVE & BEYOND





BY APPOINTMENT TO
HM THE QUEEN
MANUFACTURERS OF
MOTOR VEHICLES
JAGUAR LAND ROVER LIMITED
COVENTRY



BY APPOINTMENT TO
HRH THE DUKE OF EDINBURGH
MANUFACTURERS OF
MOTOR VEHICLES
JAGUAR LAND ROVER LIMITED
COVENTRY



BY APPOINTMENT TO
HRH THE PRINCE OF WALES
MANUFACTURERS OF
MOTOR VEHICLES
JAGUAR LAND ROVER LIMITED
COVENTRY



ABOVE & BEYOND

Ever since the first Land Rover vehicle was conceived in 1947, we have built vehicles that challenge what is possible. These in turn have challenged their owners to explore new territories and conquer difficult terrains. Our vehicles epitomise the values of the designers and engineers who have created them. Each one instilled with iconic British design cues, delivering capability with composure. Which is how we continue to break new ground, defy conventions and encourage each other to go further. Land Rover truly enables you to make more of your world, to go above and beyond.









NEW RANGE ROVER VELAR

Land Rover is proud to introduce the New Range Rover Velar. A brand new addition to the Range Rover family, sitting between the Range Rover Evoque and the Range Rover Sport. A new dimension in glamour, modernity and elegance, with emotionally charged DNA and unquestionable design pedigree.

CONTENTS

Introducing a new type of Range Rover	6	VERSATILITY	
		Truly Flexible	38
DESIGN		SPECIFY YOUR RANGE ROVER VELAR	
Celebration of Exterior Design	8	Step 1 – Choose your Model	42
Celebration of Interior Design	11	Step 2 – Choose your Engine	46
		Step 3 – Choose your Specification Pack	48
PERFORMANCE AND CAPABILITY		Step 4 – Choose your Exterior	50
Engines and Transmission	12	Step 5 – Choose your Interior	60
Refined Performance	14	Step 6 – Choose your Options and Land Rover Gear	70
Capability in all Conditions	17		
TECHNOLOGY		TECHNICAL DETAILS	78
Infotainment	21	THE WORLD OF LAND ROVER	
Audio	22	There's a World Out There	80
Connectivity	24	Your Peace of Mind	82
Driver Assistance	28		
Efficient Technologies	33		
SAFETY			
Safe and Secure	34		

Search 'Range Rover Velar' to see the vehicle in action.

Vehicle shown is R-Dynamic HSE in Silicon Silver with optional panoramic roof, Black contrast roof, privacy glass and 22" 9 split-spoke 'Style 9007' wheels with Diamond Turned finish.

INTRODUCING A NEW TYPE OF RANGE ROVER

"New Range Rover Velar's interior is a calm sanctuary, created through elegant simplicity and a visually reductive approach, with design enabled technologies like the Touch Pro Duo infotainment system. All-LED lights and deployable flush door handles on the exterior complete a truly compelling design and, of course, it's a Land Rover with unrivalled capability in all conditions. Introducing the New Range Rover Velar: the Avant-Garde Range Rover."

Gerry McGovern
Land Rover Chief Design Officer

COMPELLING DESIGN

Range Rover Velar's design is revolutionary. Its elegant sides and exemplary range of standard features such as deployable flush door handles and integrated rear spoiler all improve aerodynamic efficiency, while the foil-stamped grille gives the vehicle's front profile an undeniable presence. Sleek LED headlights and rear lights are also standard. Matrix LED and Matrix-Laser LED headlights are available as an option. See page 8 and 36 for details.

INTELLIGENT VERSATILITY

To make your journey even more comfortable, Range Rover Velar provides 970mm head clearance and 945mm knee clearance for occupants, along with exemplary loadspace of 632 litres. Optional Electronic Air Suspension* enables automatic access height for elegant entry and the option of Powered Gesture Tailgate allows simple loading with hands free access. See page 38 for details.

DISTINCTIVE INTERIOR AMBIANCE

The Range Rover Velar cabin is a calm sanctuary. Wind and road noise are minimised through the use of aerodynamic undertrays and acoustically laminated front glazing. Rear passengers can benefit from optional Reclining Rear Seats, optional Four-zone Climate Control and two optional 8" Rear Seat Entertainment screens. See page 11 for details.

DESIGN ENABLED TECHNOLOGIES

The standard Touch Pro Duo infotainment system makes life more connected and entertaining. The system seamlessly integrates two 10" high-definition Touchscreens to enable you to make a phone call on one screen while navigating on the other. Touch Pro Duo is complemented with full-colour Head-up Display, an optional state-of-the-art system providing sharp graphics and optional Interactive Driver Display with configurable touch steering wheel controls. See page 21 for details.

For full feature and option availability please refer to the accompanying Specification and Price Guide or visit your local Land Rover Retailer.

Vehicle shown is R-Dynamic HSE in Silicon Silver with optional panoramic roof, Black contrast roof, privacy glass and 22" 9 split-spoke 'Style 9007' wheels with Diamond Turned finish.

*Standard on D300 and P380 engines. Optional on D240.



OUTSTANDING CRAFTSMANSHIP AND MATERIALS

A specialist team has meticulously developed every component that you see and touch, to deliver a refined, tactile experience. Supple leathers or premium textile and suedecloth can be specified for seats, steering wheel and extensively throughout the cabin. See page 11 for details.

SPORTS COMMAND DRIVING POSITION

Range Rover Velar's Sports Command Driving Position helps deliver a more confident, engaged drive. The elevated position gives you unrivalled views, adding to the feeling of safety and security. See pages 11 and 34 for details.

CAPABILITY IN ALL CONDITIONS

Range Rover Velar has world-renowned Land Rover capability at its core. Standard features include: All Wheel Drive (AWD) with Intelligent Driveline Dynamics (IDD), Adaptive Dynamics and Torque Vectoring by Braking to deliver a connected drive. Adding to driver confidence off-road, optional features include: Electronic Air Suspension*, All Terrain Progress Control (ATPC), Terrain Response 2 and an Active Rear Locking Differential. Class-leading wading depth of up to 650mm helps provide composure and sure-footed progress in challenging conditions. See pages 14 to 19 for details.

REFINED EFFICIENT POWER

A choice of V6 engines and 4-cylinder Ingenium engines deliver efficient, refined and responsive driving. The D300 engine delivers a class-leading 700Nm of torque while the D180 engine delivers CO₂ from just 142 g/km. See page 12 for details.

DESIGN

CELEBRATION OF EXTERIOR DESIGN



Sophisticated. Intelligent. Advanced. Refined power and effortless elegance combine with exquisite effect in this outstanding example of contemporary automotive design. Range Rover Velar is beautifully balanced, with optimised proportions. Its proud Range Rover lineage is instantly recognisable, from the formal, powerful volumes of the front end, through a flowing, continuous waistline, culminating in a taut and elegantly tapered rear.



The sleek volumes of the lower body, with its flawlessly integrated deployable flush door handles, bear witness to our obsession with the finest detail. Optional 22" wheels optimise the vehicle's stunning proportions, further emphasising Range Rover Velar's spectacular on road presence. At the rear, the vehicle's design is distinguished by quad tail light signature elements within a full-width graphic incorporating the iconic Range Rover script, seamlessly harmonising the vehicle's lines to stunning effect.

Search 'Range Rover Velar Design' for full details.





CELEBRATION OF INTERIOR DESIGN

Range Rover Velar's cabin exudes elegant simplicity. The familiar Range Rover interior design architecture, with its strong elegant horizontal lines, blends seamlessly with innovative features to give a feeling of calm, and enhance the driving experience.

Two seamlessly integrated 10" Touchscreens and minimalist controls as standard, give easy control of the latest advanced technology. As the vehicle is started and comes to life, the revolutionary Touch Pro Duo technology reinforces the overall sense of luxury and innovation.

Everything has been designed and crafted to help you and your passengers arrive relaxed. The twin sliding armrests, which operate independently, help maximise your individual comfort. Beautiful materials, including optional Windsor leather with a signature Cut Diamond pattern throughout the cabin, add a contemporary twist. Modern premium textiles, expertly constructed in collaboration with Europe's leading manufacturer of high quality and design led textiles, Kvadrat, are offered as an alternative to leather.

The elevated position of our renowned Sports Command Driving Position, enables you to see further down the road and view your surroundings with greater clarity so you stay in control no matter what the conditions or traffic.

The option of Configurable Ambient Interior Lighting in a choice of ten colours creates the right mood. Whilst the optional sliding panoramic or fixed panoramic roof floods the cabin with light, bringing the outside in.

Search 'Range Rover Velar Design' for full details.



Sliding Panoramic Roof



Windsor leather with Cut Diamond pattern



Fixed Panoramic Roof

Interior shown is R-Dynamic HSE with Light Oyster/Ebony interior in Windsor leather with sliding panoramic roof and optional features.

PERFORMANCE AND CAPABILITY

ENGINES AND TRANSMISSION

From power and sheer driving pleasure to fuel economy and refinement, there is a range of engines available for Range Rover Velar and each has been optimised for specific attributes to cater for all needs. All engines are equipped with Stop/Start technology and smart regenerative charging; this feature harvests kinetic energy from braking to charge the battery for maximum economy, especially during urban driving. Ingenium technology underpins all of the 4-cylinder engines in the Range Rover Velar range. These low friction, all-aluminium engines have stiff cylinder blocks and twin balancer shafts to ensure inherently low levels of vibration, for smooth day-to-day performance.

Search 'Range Rover Velar Performance' for full details.



DIESEL ENGINES

D180

The Ingenium 2.0 litre 4-cylinder 180hp Turbocharged Diesel engine produces 430Nm of torque and is optimised to deliver the best fuel economy in the range.

- High-pressure common rail direct fuel injection, exhaust variable cam timing and a high-efficiency water-cooled intercooler work in combination for a clean, efficient combustion.
- Intelligent, electronically controlled, adaptive engine cooling only engages when required – minimising fuel consumption and CO₂ emissions.
- The engine features a variable geometry turbocharger that adapts to the changing flow of exhaust gases for high torque throughout the rev range and responsiveness that is uniform, progressive and reduces lag.

D240

The Ingenium 2.0 litre 4-cylinder 240hp Twin Turbocharged Diesel engine produces 500Nm of torque, which improves upon performance whilst maintaining impressive fuel economy.

- Series sequential twin turbochargers deliver an ideal combination of peak power performance and superior low speed driveability.
- Upgrades include a higher-pressure common rail fuel system, increased from 1,800 to 2,200 bar, and an increased fuel injector flow rate. These combine to deliver optimised fuel economy, emissions and power delivery.
- The result is an engine that pushes performance boundaries of a 4-cylinder with the strong fuel economy inherent in the Ingenium range.

D300

The 3.0 litre V6 300hp Twin Turbocharged Diesel engine produces 700Nm of torque and is ideal for higher power and torque demand usage with exceptional driveability.

- Innovative parallel sequential twin turbochargers – a concept pioneered by Jaguar Land Rover – feature a ceramic ball bearing on the primary turbo to reduce friction for maximum throttle response.
- A switchable coolant pump and two-stage oil pump are used for optimal thermal energy management, improving operating efficiency.
- The Piezo common rail fuel injection system enables precise control of the amount of fuel injected, creating a uniform mixture for more efficient combustion and lower emissions.
- The engine utilises these technologies to offer premium refinement and performance, whilst maintaining impressive fuel economy.

	HP	NM				CO ₂	CC
	POWER (HP)	TORQUE (NM)	ACCELERATION 0-60 MPH (SECONDS)	TOP SPEED (MPH)	FUEL CONSUMPTION (MPG)	CO ₂ EMISSIONS (G/KM)	CAPACITY (CC)
D180*	180	430	8.4	130	52.5	From 142	1,999
D240	240	500	6.8	135	48.7	From 154	1,999
D300	300	700	6.1	150	44.1	From 167	2,993

*If vehicle is fitted with 18" wheels the top speed will be 120 mph.

8-SPEED AUTOMATIC TRANSMISSION

All Diesel and Petrol engines in Range Rover Velar are coupled with an 8-speed Automatic Transmission. With eight closely spaced ratios, the transmission ensures that you are always in the optimum gear, maximising fuel efficiency and acceleration. Gear changes are almost imperceptible and shift schedules intelligently adapt to your driving style.



PETROL ENGINES

P250

The Ingenium 2.0 litre 4-cylinder 250hp Turbocharged Petrol engine produces 365Nm of torque and delivers outstanding fuel economy and driveability.

- The intelligent Continuously Variable Valve Lift (CVVL) system varies the extent to which inlet valves are opened, reducing engine-pumping losses. This lets the engine 'breathe' with maximum efficiency, optimising power and torque.
- CVVL works in combination with dual independent variable cam timing for ultimate operating flexibility, resulting in excellent power and fuel economy across the rev range.
- For excellent acceleration and effortless overtaking, maximum torque is available between 1,200-4,500rpm.
- The twin scroll turbocharger is fed by an integrated exhaust manifold which increases the transfer of energy to the turbine – significantly reducing turbo lag and improving engine response.

P380

The 3.0 litre V6 380hp Supercharged Petrol engine produces 450Nm of torque and is the top of the range for ultimate performance.

- The Roots-type twin vortex supercharger provides linear power delivery and maximises responsiveness.
- A spray guided direct injection system carefully manages the air-fuel mixture in the combustion chamber for improved combustion, extracting more energy from the fuel injected. This results in excellent power, while improving fuel economy and reducing emissions.
- The engine also features dual independent variable cam timing to vary inlet and exhaust valve operation, working alongside lightweight pistons with ultra-low friction piston rings, for increased performance and efficiency.
- A twin, contra-rotating balancer shaft system is employed to maximise refinement; resulting in an engine with incredibly smooth power delivery.

	HP	NM				CO ₂	CC
	POWER (HP)	TORQUE (NM)	ACCELERATION 0-60 MPH (SECONDS)	TOP SPEED (MPH)	FUEL CONSUMPTION (MPG)	CO ₂ EMISSIONS (G/KM)	CAPACITY (CC)
P250	250	365	6.4	135	37.2	From 173	1,998
P380	380	450	5.3	155	30.1	From 214	2,995

REFINED PERFORMANCE

Range Rover Velar's drive is supremely confident, connected and effortlessly delivered thanks to a carefully engineered suite of technologies.

ALL WHEEL DRIVE WITH INTELLIGENT DRIVELINE DYNAMICS

Range Rover Velar's All Wheel Drive (AWD) with Intelligent Driveline Dynamics (IDD) fitted as standard delivers both outstanding on-road performance and the full off-road capability expected of a Range Rover. Working together, AWD with IDD continually optimises the engine torque distribution to the front and rear wheels to ensure maximum traction and fuel efficiency in all road and weather conditions. Uniquely developed to meet Range Rover Velar's requirements, the highly durable transfer box uses an electro-mechanically activated multi-plate wet clutch to deliver smooth and precise distribution to the front and rear wheels. This ensures the constant optimisation is imperceptible from the cabin and available engine torque is maximised to give efficient vehicle traction.

IDD determines the required distribution by continually monitoring the vehicle and its interaction with the road. Typically starting with a 50:50 distribution to ensure maximum controlled stability from the first vehicle movement, the system has the full capability of 100 percent rear bias to 100 percent front bias should road conditions require it. Predictive, as well as reactive, the system helps prevent losing traction as well as working to regain it.

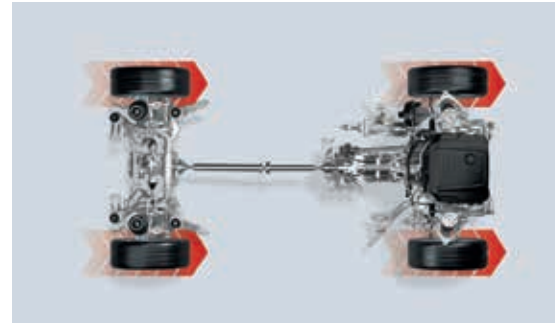

LOW TRACTION CONDITIONS

On slippery surfaces, such as wet grass and snow, torque can be balanced between the front and rear wheels to maximise traction. In extreme conditions where only the front wheels have traction, up to 100 percent of engine torque can be distributed to the front wheels for optimum grip.

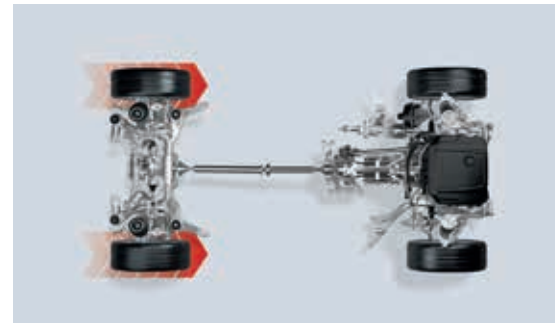

HIGH TRACTION CONDITIONS

On smooth, dry surfaces, Range Rover Velar provides intelligent torque distribution to the rear wheels for the most efficient drive as well as delivering precise agility and handling.

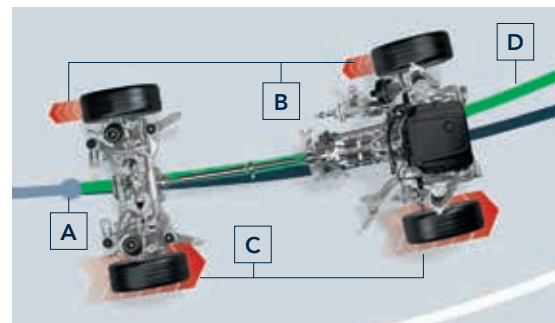

TORQUE VECTORING BY BRAKING

Torque Vectoring by Braking delivers controlled, responsive cornering by reducing near-limit understeer through controlled braking of the inside wheels.

- A** Understeer detected
- B** Braking force to inner wheels
- C** Torque to outside wheels maintained
- D** Line corrected

ADAPTIVE DYNAMICS

The standard Adaptive Dynamics system delivers both precise dynamics and a supple, luxurious ride by monitoring wheel position and body movements. To do this, the system constantly analyses acceleration, steering, throttle and brake pedal activity. The electronically controlled dampers adjust to optimise the suspension settings and provide the optimum balance between comfort, refinement and agility at all times.

CONFIGURABLE DYNAMICS

To enhance either refinement and comfort or the vehicle's performance, the optional Configurable Dynamics function allows you to configure Range Rover Velar's throttle mapping, gearbox shift points, steering settings and suspension to suit your driving needs. Search 'Range Rover Velar Capability' for full details.







CAPABILITY IN ALL CONDITIONS

The first vehicle to combine luxury and refinement with world-renowned all-condition capability, Range Rover continues to be leading-edge. Range Rover Velar offers new levels of style, whilst its unique Land Rover technologies and optimised geometry secure its position at the forefront of all-terrain capability.

Land Rover's patented Hill Descent Control (HDC) is a standard feature. It assists the driver with controlled descents of difficult slopes. It does so by maintaining a constant speed and applying braking separately to each wheel. Hill Launch Assist, which also comes as standard, ensures the vehicle doesn't roll backwards as it pulls away on an incline. The vehicle also utilises Gradient Release Control, which again comes as standard, and is designed to prevent the vehicle accelerating too quickly on a steep incline when the driver releases the brake.

ELECTRONIC AIR SUSPENSION

A sure-footed, composed drive is completed by the latest optional Electronic Air Suspension*, which provides exceptional wheel articulation and poise. It changes the vehicle's height quickly, allowing cross-linking of the diagonal wheels to keep all four wheels on the ground on very uneven surfaces. Added to which, it makes loading heavy objects into the boot easier as you can alter the vehicle's height by +/- 50mm to suit your needs. These functions can be operated via the 10" Touchscreen or button** in the loadspace area. The Speed Lowering System also uses the Electronic Air Suspension to reduce aerodynamic drag and fuel consumption at cruising speeds by lowering the vehicle by 10mm from normal ride-height when the speed reaches 65mph.

ALL TERRAIN PROGRESS CONTROL

All Terrain Progress Control (ATPC) is a state-of-the-art optional system that enables you to set and maintain a steady speed in challenging conditions such as slippery surfaces, including: mud, wet grass, ice, snow and dirt roads. Operating like a cruise control system, it functions between 1mph and 18mph, enabling you to maintain full concentration on steering and finding a path through obstacles.

*Standard on D300 and P380 engines. Optional on D240. **Only available when optional towing equipment is selected.

Vehicle shown is R-Dynamic HSE in Silicon Silver with optional panoramic roof, Black contrast roof. Privacy glass and 22" 9 split-spoke 'Style 9007' wheels with Diamond Turned finish.



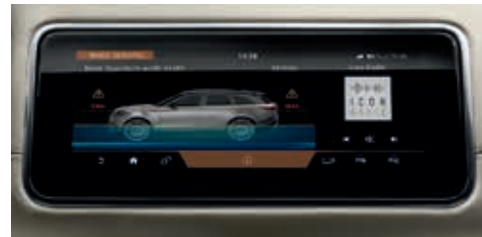

TERRAIN RESPONSE

When you manually select Land Rover's unique standard Terrain Response system, it sets the vehicle up optimally to match the demands of the terrain, by adapting the responses of the vehicle's engine, gearbox, differentials and chassis systems. There are six Terrain Response settings: Comfort, Grass/Gravel/Snow, Mud and Ruts, Sand, ECO and Dynamic Mode.

TERRAIN RESPONSE 2

Terrain Response 2 is an option that takes the capabilities of the award-winning system to a new level. This features an automatic setting which monitors the current driving conditions and systematically selects the most suitable terrain setting. You can manually override the system should you wish. This function works seamlessly through the Touch Pro Duo's Control Panel (lower Touchscreen).

WADE SENSING

Unique to Land Rover, this optional system uses ultrasonic sensors in the wing mirrors to visually and audibly alert the driver if the water approaches the vehicle's class-leading wading depth of up to 650mm*. It does so by providing real-time pictorial information via the Touchscreen about its depth in relation to the vehicle and its maximum wading capability. Only available with optional Surround Camera System.



SAFETY

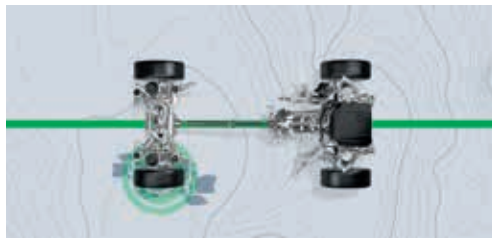

ULTIMATE CAPABILITY



COMPOSURE

ACTIVE LOCKING REAR DIFFERENTIAL

The Active Locking Rear Differential** ensures the greatest level of traction in all weather conditions both on and off-road.

A typical open differential transfers equal torque to the driven wheels meaning that if one wheel slips then torque transfer to the other wheel is also limited, which reduces traction. Whereas, Range Rover Velar's All Wheel Drive (AWD) with Intelligent Driveline Dynamics (IDD)[†] and Electronic Traction Control (ETC)[†], both fitted as standard, go two steps further by distributing torque to both the front and the rear wheels, and by braking the wheels independently to improve traction respectively. The addition of the Active Locking Rear Differential delivers the ultimate combination to maximise traction through limiting slip across the rear wheels.

A second multi-plate wet clutch between the rear wheels can lock almost instantly to provide full engine output torque to both wheels. This can be especially useful to deliver effortless capability in low grip conditions such as patchy ice, wet grass or during wheel articulation off-road. It also provides maximum traction when exiting a corner, as when the inside wheel becomes unloaded due to weight transfer, the Active Locking Rear Differential increases the torque to the outside wheel.

Search 'Range Rover Velar Capability' for full details.

Vehicles shown are R-Dynamic HSE in Silicon Silver with optional sliding panoramic roof, Black contrast roof, privacy glass and 22" 9 split-spoke 'Style 9007' wheels with Diamond Turned finish.



TECHNOLOGY

INFOTAINMENT

Unique to Land Rover, the new InControl infotainment system, Touch Pro Duo not only looks like no other, it performs like no other. Delivering a wealth of information and entertainment, it features the most intuitive and advanced integrated technologies to ensure everyone can make the most of their journey.

Search 'Range Rover Velar Technology' for full details.



TOUCH PRO DUO

The new standard 10" dual high-definition Touchscreens allow the user to view required information whilst simultaneously being able to interact with additional features, for increased flexibility and efficiency of use. For instance, you can use the navigation system* in the upper screen whilst controlling media on the lower screen. Direct access to cabin and seat temperature controls are also available via the new multi-function Dynamic Dials.

For a truly elegant and streamlined appearance, the steering wheel also has new hidden-until-lit, touch-sensitive switches as standard. One of these switches is programmable, so that it can be personalised to your preferences to accomplish a host of functions.



INTERACTIVE DRIVER DISPLAY

Range Rover Velar ensures you're always entertained, informed and connected. It features an optional 12.3" high-definition Interactive Driver Display** that can receive and project a vast amount of driving information, entertainment and active safety data including navigation, phone and media. Its high resolution ensures the utmost clarity and its refined processing engine delivers smooth moving pin sharp graphics. Features can be accessed on either the Interactive Driver Display or the Touch Pro Duo Touchscreens.



HEAD-UP DISPLAY

Without distraction or the need for you to take your eyes off the road, Head-up Display† is an option that presents key vehicle data such as your speed, gear position and navigation directions on the windscreen. It features crystal clear full-colour graphics in high resolution, enabling you to see all driver inputs and information with ease. It can also display important information from the Touch Pro Duo Touchscreen including phone and media information such as the name of the track you are listening to. The feature can be turned on and off dependent on driver preference.



REAR SEAT ENTERTAINMENT

The optional Rear Seat Entertainment System provides two 8" screens built in to the rear of the front headrests. It includes 'Journey Status', a Navigation Summary screen which displays a pop-up for the rear occupant detailing the time and distance to destination. The system comes with two pairs of WhiteFire® digital wireless headphones and HDMI, Mobile High-Definition Link (MHL) and USB connections. Passengers can also enjoy their favourite TV shows via the optional Digital TV feature. Digital TV channels can be watched on the 10" Touchscreen† in the front cabin and the Rear Seat Entertainment screens.

*Included within S, SE and HSE Specification Packs or optional **Included within SE and HSE Specification Packs or optional

†Image shown with optional Traffic Sign Recognition and Adaptive Speed Limiter

‡Digital TV can only be viewed on the 10" Touchscreen when the vehicle is stationary.

Interior shown is R-Dynamic HSE with Light Oyster/Ebony interior in Windsor leather with optional features.

WhiteFire® is a registered trademark of Unwired Technology LLC and any use of such marks by Land Rover is under licence.

AUDIO

A vehicle's cabin is the ideal place within which to experience your personal choice of music and Range Rover Velar has the option of four different audio systems to bring your music to life:



LAND ROVER SOUND SYSTEM

Outstanding acoustic range through eight speakers. Standard on Velar.

MERIDIAN™ SOUND SYSTEM

Great definition, crystal clear highs and full, deep bass – delivered through the careful arrangement of 11 speakers including a dual channel subwoofer. Standard on S Specification Pack. Optional on Velar.

MERIDIAN SURROUND SOUND SYSTEM

All the fullness and clarity of a live performance delivered through an arrangement of 17 front, side and rear speakers including a dual channel subwoofer – seamlessly brought together using Trifield™ technology. Exclusive to Meridian, Trifield perfectly blends the centre and surround channels with left and right channels ensuring an optimum, consistent sound experience for each passenger. Standard on SE and HSE Specification Packs. Optional on Velar and S Specification Pack.

MERIDIAN SIGNATURE SOUND SYSTEM

This delivers truly life-like reproduction, creating a profound, personal sound experience for every seat. World-first Trifield 3D technology takes surround sound to the next level, the Signature Sound System includes 23 speakers including a dual channel subwoofer. Incredibly authentic, the sense of cabin space is expanded to a 3D experience – rendering all the instruments, performers and venues of your favourite performances in true scale and location. Standard on First Edition. Optional on all other models.

DAB RADIO











DAB radio technology is standard on all models and offers improved sound quality, a wide choice of stations and live text information about the station, show and song you are listening to.

MERIDIAN

Formed in 1977 in Cambridgeshire, England, Land Rover’s audio partner Meridian has pioneered many firsts including active speakers and the world’s first digital surround sound processor.

Meridian’s audio technology input has helped ensure that Range Rover Velar is the most superb space within which to experience sound. Meridian Cabin Correction technology was utilised to analyse cabin shape, acoustics and resonance characteristics in order to help remove unwanted sounds.

The advanced algorithm ensures that the rhythm, punch and timing of any piece of music are heard precisely how the artist intended, providing a consistently exceptional quality audio experience for all passengers in the vehicle.

	UNIQUE MERIDIAN TECHNOLOGY	SPEAKERS	WATTS
LAND ROVER SOUND SYSTEM	N/A	8	250
MERIDIAN SOUND SYSTEM	  	11	380
MERIDIAN SURROUND SOUND SYSTEM	   	17	825
MERIDIAN SIGNATURE SOUND SYSTEM	   	23	1600

Search 'Range Rover Velar Technology' for full details.



DIGITAL SIGNAL PROCESSING

Brings all elements of the audio system together as one, for performance that would otherwise require significantly larger speakers.



MERIDIAN CABIN CORRECTION

The advanced algorithm of Meridian’s Cabin Correction tailors the sound experience to the precise acoustics of Range Rover Velar’s interior.



MERIDIAN DIGITAL DITHER SHAPING

To maintain the quality of musical recordings, they are converted into a common digital format. Meridian Digital Dither Shaping ensures that digital signal conversions are made smoothly and seamlessly, preserving the finest details of the audio performance. The result is authentic musical conversion, evoking the emotions of the original recording.



TRIFIELD

Exclusive to Meridian, Trifield blends the centre and surround channels seamlessly with left and right channels, delivering a consistent, concert-like experience for all occupants.



TRIFIELD 3D

Building on Meridian’s proven Trifield surround sound technology – world-first in-car Trifield 3D truly brings musical performances to life. Through the addition of dedicated height channels, the sense of cabin space is expanded to a 3D experience, for a supreme sense of scale and definition to your music.



CONNECTIVITY

InControl is Land Rover's suite of standard and optional features that connects you to your vehicle and links you seamlessly, and securely, with the outside world. Select from three available packs, that can be further enhanced by our individually offered feature, Secure Tracker. With a selection of apps, even when you're away from your vehicle, some of the InControl features stay with you, making sure the Land Rover experience is more enjoyable than ever.

Search 'Range Rover Velar Technology' for full details.

STANDARD FEATURES

VOICE RECOGNITION SYSTEM

Understands clear spoken instructions, so you can concentrate on the road ahead without any distractions.

INCONTROL REMOTE

InControl Remote app provides upgraded information on your vehicle and enables you to interact with it remotely. Compatible with most smartphones, Android™ Wear or the Apple Watch®, this service includes:

- **Remote Lock/Unlock** – Lock or unlock your doors remotely with the click of a button. Simply press the 'lock' button on the Vehicle Security screen of the InControl Remote smartphone app to single lock the doors, arm the alarm, fold in the wing mirrors and close the windows. Press the 'unlock' button to unfold the wing mirrors, turn on the dipped headlights and cause the hazard lights to flash twice.
- **Remote Climate** – Prepare your Land Rover in advance by pre-heating or pre-cooling the cabin, so that you and your passengers are comfortable from the moment you step inside.
- **Beep/Flash** – This feature turns on your Land Rover's hazard lights, dipped headlights and sounds an audible alert to help you locate your vehicle in a crowded car park.
- **Journey Tracking** – This opt-in feature can automatically record your journey history including your route and mileage statistics. This information can be exported by email to use for expense reporting and can be imported to a spreadsheet.
- **Vehicle Status Check** – Check current fuel level and range, and status of door and window position and locks. See the last parked location of the vehicle and find your way back to it with on-foot directions.

Land Rover Optimised Assistance – If you break down you can make a direct call to the Land Rover Assistance team by pressing the button on the overhead console or from the Assistance screen within the InControl Remote smartphone app.

SOS Emergency Call – In a more serious incident, SOS Emergency Call will automatically connect you to the emergency response team who will notify the emergency services to your location.

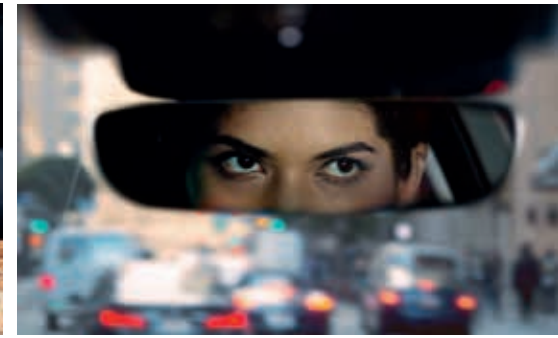

Information and images displayed in relation to the InControl technology, including screens or sequences, are subject to software updates, version control and other system/visual changes depending on options selected. Certain features require the fitment of a Micro Sim with a suitable data contract and Pro Services which will require further subscription after the initial term advised by your Retailer. Android™ is a trademark of Google Inc. Apple Watch® is a registered trademark of Apple Inc., registered in the US and other countries. Mobile network connectivity cannot be guaranteed in all locations. InControl Apps will need to be downloaded from the Apple/Play Store.

OPTIONAL FEATURES

NAVIGATION PRO

Standard on S, SE and HSE, Navigation Pro allows you to save your favourite places, use pinch and zoom gestures for simple map exploration and can display a choice of either 2D or 3D crystal clear map graphics. Navigation Pro functionality is further enhanced by **Pro Services**.

PRO SERVICES AND WI-FI HOTSPOT

Pro Services and Wi-Fi Hotspot is designed to enhance your in-car and out-of-car experience, ensuring you and your passengers enjoy the journey whilst remaining connected to the world.

Pro Services include:

- **Real Time Traffic Information** – Uses live traffic data feeds to give you the most accurate picture of what the traffic is like on the way to your destination.
- **Online Search** – Wherever you are, you can search the surrounding area for places of interest. The system can access expert destination information, travel tips and inspiration as well as online travel reviews of the local area.
- **Planning Routes and Door-to-Door Routing** – Before setting off, use the Route Planner app or online to search, save locations or set your destination. The app uses the Cloud to send your destination automatically to your vehicle's navigation screen. Once you've parked, the Route Planner app will guide you to your destination – a true door-to-door experience which includes public transport options.
- **Share ETA** – You can share your estimated time of arrival so your selected contact(s) will know exactly when you will arrive, as calculated by the navigation guidance system. If you're running late, Share ETA can then send automatic updates via text messages or email, without any further action from you.
- **Satellite View** – There may be times when you want to get the context of your surroundings from overhead. With Pro Services you can switch to satellite view with a single tap.
- **Street Level Imagery** – To help you recognise your destination as you approach it, the screen can display a 360 degree panoramic street level image.
- **Fuel Prices** – When you're going to fill up, the Fuel Price service not only finds filling stations along your route, it also enables you to compare fuel prices, where available, so you can keep your costs down.
- **Commute Mode** – Allows the system to learn your commutes and automatically advises you of the expected journey time based on live and historical traffic movements without you having to input a destination. The system learns the routes you take for a given destination and then advises which of those is the quickest. The feature can be turned on and off dependent on driver preference.

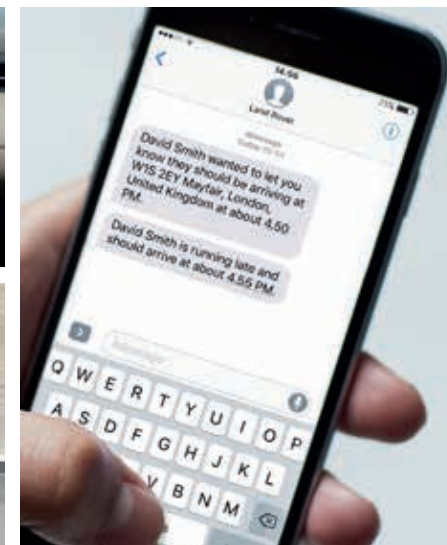
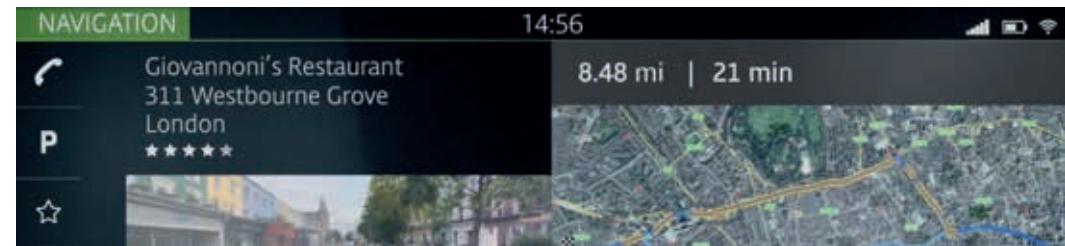

Information and images displayed in relation to the InControl technology, including screens or sequences, are subject to software updates, version control and other system/visual changes depending on options selected. Certain features require the fitment of Pro Services and a Micro SIM with a suitable data contract. Mobile network connectivity cannot be guaranteed in all locations. InControl Apps will need to be downloaded from the Apple/Play Store.

PRO SERVICES AND WI-FI HOTSPOT CONTINUED

- **Parking Service** – As you approach your destination, you can see where parking is available. Simply tap on your preferred car park and the navigation system updates to direct you to it.
- **Online Routing** – While you're on your way to a destination the system monitors live traffic conditions and takes into account typical traffic patterns for that time of day, keeping you on the optimum route.
- **Safety Cameras** – This feature tells you when you're approaching a safety camera.

SMARTPHONE PACK

Land Rover InControl Apps technology allows vehicle-optimised apps on your Android or Apple smartphone to be controlled through the vehicle's Touchscreen, including contacts, calendar and music player via a USB cable to the USB slot. You can also download third-party apps offering a vast range of services. Applications include:

- **Spotify*** – Access a library of more than 30 million songs with this seamlessly integrated app – the first true in-car, Spotify experience. Featuring all the same intuitive functionality as the Spotify smartphone app, you can search songs, stations and recommendations, create playlists and access your music in offline mode.
- **Tile**** – Helps you find lost or misplaced items in seconds. Attach a tiny Bluetooth® tracker Tile to your keys, wallet or bag. The easy-to-use Tile app can then help you find these items should they be misplaced. The app is accessible any time through your vehicle's Touchscreen, allowing you to make sure you have everything you need with you, before you set off on your journey.

SECURE TRACKER

Uses tracking technology to alert you to an attempted theft, and signals your vehicle's location to the relevant authorities, for a timely recovery.

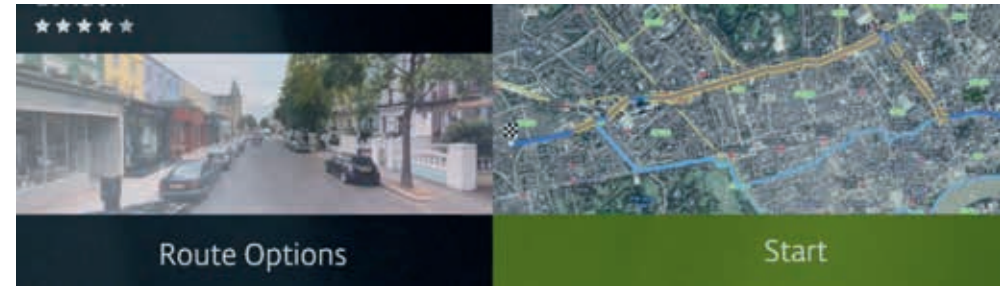

*Only available on Apple smartphones. Not available on Android smartphones.
**Requires InControl Apps ©2016 Tile Inc. Tile and the Tile design are trademarks of Tile, Inc.
The Bluetooth® word mark and logos are owned by the Bluetooth SIG, Inc. and any use of such marks by Land Rover is under licence.

DRIVER ASSISTANCE

MAKING DRIVING EASIER

From negotiating city traffic or the motorway, to providing additional safety for you and your passengers, there's a wealth of innovative technologies available; either as standard, optional or as part of an optional pack. Whichever you choose, you'll find every single feature has been designed and engineered to heighten your enjoyment of the vehicle.

Search 'Range Rover Velar Technology' for full details.

STANDARD DRIVE FEATURES



Lane Departure Warning

Cruise Control with Speed Limiter allows the driver to maintain the current speed of the vehicle without the need for continued use of the accelerator pedal, helping to reduce driver fatigue. The Speed Limiter will also allow the driver to pre-set a maximum specified speed which the vehicle will not exceed. Both functions can be easily turned on or off by the driver as desired.

Autonomous Emergency Braking can help to prevent collisions with other vehicles or pedestrians. If a potential frontal collision is detected, a warning is displayed giving you time to take action. A camera at the front of the vehicle monitors at speeds from 3 to 50mph for frontal collisions and 3 to 37mph for pedestrians. If a collision is still anticipated and you have taken no action, this system will apply the brakes to help reduce the severity of the possible impact.

Lane Departure Warning can help make long journeys much safer. The system senses when your vehicle is unintentionally drifting out of your lane, and notifies you with a visual alert and a gentle vibration of the steering wheel.

OPTIONAL DRIVE FEATURES



Adaptive Cruise Control with Queue Assist and Intelligent Emergency Braking

Adaptive Cruise Control with Queue Assist and Intelligent Emergency Braking works when you're cruising on the motorway or travelling in slow-moving traffic, it will keep your vehicle a set distance from the one in front should it slow or stop. Should the vehicle in front stop completely, your vehicle will come to a smooth halt. Once the traffic moves, simply touch the accelerator and Adaptive Cruise Control will resume following the vehicle in front. The system can be activated from 10mph up to motorway speeds.

If a collision is unavoidable, Adaptive Cruise Control will engage Intelligent Emergency Braking. This system can help reduce injuries and damage by automatically applying the brakes.

DRIVE PACKS

OPTIONAL DRIVE PACK*



Traffic Sign Recognition with Adaptive Speed Limiter

The optional Drive Pack offers a range of features that help keep you safe and informed. The Drive Pack includes:

Driver Condition Monitor detects if you're starting to feel drowsy and gives you an early warning when you need to take a break.

Blind Spot Monitor alerts you to vehicles in, or quickly approaching your blind spot. When a vehicle is detected, a small warning light will illuminate in the corresponding wing mirror. If you indicate in the direction of the obstacle, the warning light will flash to highlight potential danger.

Traffic Sign Recognition keeps you informed and aware on the road, by displaying speed limits and no overtaking signs in the instrument cluster, where they can easily be seen. When activated, Adaptive Speed Limiter uses Traffic Sign Recognition information to adjust your vehicle's speed accordingly.

OPTIONAL DRIVE PRO PACK*



Blind Spot Assist

Making every journey safer and more relaxing. The optional Drive Pro Pack contains all the technologies within the Drive Pack, plus the following enhancements:

Lane Keep Assist detects when your vehicle is unintentionally drifting out of your lane, and gently steers you back.

Blind Spot Assist can help prevent collisions. If your vehicle detects another car in your blind spot when you begin to change lanes, this system provides precisely calculated steering torque – guiding your vehicle safely away from the approaching car.

Adaptive Cruise Control with Queue Assist and Intelligent Emergency Braking – See page 28 for description.

*Available on Range Rover Velar models when auto-dimming, power fold, heated door mirrors with approach lights are selected. Drive Pack is standard on SE Specification Pack and Drive Pro Pack is standard on HSE Specification Pack and First Edition.

ENJOY STRESS-FREE PARKING

Range Rover Velar offers the most advanced technologies to deliver intuitive and easy parking solutions. Whether reversing, parallel parking or getting into or out of tight spaces, these features make life easier. Available as standard, optional or as part of an optional pack.

Search 'Range Rover Velar Technology' for full details.

STANDARD PARK FEATURES



Rear Parking Aid

Rear Parking Aid helps make reversing into tight spaces safer. When you select Reverse, sensors located in the rear bumper are automatically triggered. As you park, the Touchscreen display and audio feedback indicates how close you are to obstacles.

OPTIONAL PARK FEATURES



Surround Camera System

Front and Rear Parking Aid helps make manoeuvring even easier. When you select Reverse, or choose to activate them manually, sensors located in the front and rear bumpers are triggered. As you park, the Touchscreen display and audio feedback indicates how close you are to obstacles.

Rear View Camera provides improved visibility when reversing. This valuable parking aid also helps when hitching a trailer. Static lines representing the vehicle's outer perimeter and predicted path are superimposed on the rearward image, to make parking in tight spots as easy as possible. Standard on S, SE and HSE Specification Packs.

Surround Camera System* uses four digital cameras discretely placed around the vehicle, providing a 360° overhead view on the Touchscreen. With the capacity to display several different views at the same time, this helps with various manoeuvres from parking by a kerb, to getting in and out of tight spaces and junctions. Standard on First Edition.

*Available on Range Rover Velar models when auto-dimming, power fold, heated door mirrors with approach lights are selected

**Park Pack is standard on SE Specification Pack. Park Pro Pack is standard on HSE Specification Pack and First Edition.

PARK PACKS

OPTIONAL PARK PACK**



360° Parking Aid

The optional Park Pack assists you with manoeuvring in tight spaces and in urban environments, it features:

360° Parking Aid gives you complete confidence when manoeuvring in tight spaces. Sensors located around the vehicle are automatically triggered when reverse is selected, or can be manually activated, with a graphic appearing on the Touchscreen showing an overhead view of the vehicle. As you park, the Touchscreen display and audio feedback indicates how close you are to obstacles.

Reverse Traffic Detection is particularly useful when reversing out of a parking bay, the system warns you of vehicles, pedestrians or other hazards, approaching from either side of your vehicle. It will alert you with both audio and visual warnings so you know what's behind you even when the view is obstructed.

OPTIONAL PARK PRO PACK**



Park Assist

The optional Park Pro Pack enables you to park and manoeuvre safely and securely in and out of tight spaces and into traffic that is obscured by buildings or other vehicles. The pack contains all the technologies within the Park Pack, plus the following enhancement:

Park Assist (includes 360° Parking Aid) makes parallel and perpendicular parking easier than ever by steering your vehicle into a suitable space. You just have to select the appropriate gear and control the vehicle's speed with the brake and accelerator pedals. Graphics and notifications guide you through the manoeuvres. Park Assist will also steer you out of a space, taking all of the stress out of parking.



EFFICIENT TECHNOLOGIES

SUSTAINABLE BY DESIGN

Land Rover are committed to producing vehicles that use more sustainable materials, produce less waste and use fewer natural resources as part of our approach to sustainability excellence. Range Rover Velar's development process has included a full life cycle assessment and has been designed to be 85 percent recyclable/re-usable and 95 percent recoverable at the end of the vehicle's life.

Due to its advanced lightweight properties, Range Rover Velar's body structure is 82 percent aluminium. Our innovative design incorporates up to 50 percent closed-loop recycled material from the manufacturing process of the body sheet, resulting in significant performance benefits and lower life cycle CO₂ emissions. The closed-loop supply chain reclaims scrap aluminium from the stamping process, segregates it and re-melts it into the same grade quality sheet, thereby reducing the need for primary aluminium production, whilst maintaining the highest quality.

ADVANCED AERODYNAMICS

The streamlined design of our latest vehicle has been carefully optimised to make Range Rover Velar the most aerodynamic Range Rover ever. A rear spoiler with two integrated slots to direct airflow over the tailgate minimises rear windscreen soiling and provides a reduction in drag of 0.32 CdA. The option of aerodynamically designed and engineered wheels can also help reduce drag by 5%.

ENGINE MANUFACTURING CENTRE

Jaguar Land Rover's Engine Manufacturing Centre, where our engines are developed, has been built to the highest environmental standard (BREEAM Excellent) and features the largest rooftop solar panel installation in the UK. Comprising no fewer than 22,600 individual panels, which are capable of providing up to 6.2MW (enough energy to power up to 1,600 homes), the panels generate more than 30 percent of the site's energy, reducing the plant's CO₂ footprint by over 2,400 tonnes per year.

Search 'Range Rover Velar Sustainability' for full details.



Vehicle shown is R-Dynamic HSE in Silicon Silver with optional panoramic roof, Black contrast roof, privacy glass and 22" 9 split-spoke 'Style 9007' wheels with Diamond Turned finish.

SAFETY

SAFE AND SECURE

Designed for optimum safety, Range Rover Velar has been engineered to include a wealth of standard features not only to protect you and your passengers, but to actively help prevent accidents from happening.

Range Rover Velar's elevated Sports Command Driving Position provides enhanced visibility in all conditions. You can see more of the road and be easily seen by other road users, providing an enhanced feeling of safety and confidence.

Legendary sure-footed All Wheel Drive (AWD) with Intelligent Driveline Dynamic (IDD) capability, as standard, helps you stay firmly planted on the road, whatever the weather or environment throws at you.

The safety of Range Rover Velar is further enhanced by the latest technologies included as standard:

Dynamic Stability Control (DSC) monitors Range Rover Velar's dynamic behaviour, intervening to maximise vehicle stability. DSC reduces engine torque and applies braking to the appropriate wheels to correct the vehicle's direction of travel by counteracting understeer or oversteer.

Anti-lock Braking System (ABS) allows the vehicle to maintain traction with the road surface whilst braking and prevents wheels from locking – thereby retaining the vehicle's ability to steer. The system helps to shorten the braking distance.

Electronic Brake-force Distribution (EBD) automatically varies the braking force to each wheel in order to minimise stopping distance, while still maintaining stability and the vehicle's ability to steer.

Electronic Traction Control (ETC) optimises traction and stability by controlling wheel spin. The ETC system reduces torque to the spinning wheel, then applies braking to the wheel, if required.



Cornering Brake Control (CBC) automatically varies the braking force to each wheel when the vehicle's brakes are applied around a corner and the limit of grip is reached. The system will prevent the vehicle's wheels from locking up and skidding in this event through varying the braking force applied to each wheel.

Roll Stability Control (RSC) is integrated with DSC to reduce the possibility of rollover, while providing agility and ability to steer around obstacles. It monitors the vehicle motion and cornering forces to detect any potential risk of rollover. When risk is detected, braking is applied to the outside front wheel to reduce forces which contribute to rollover.

Emergency Brake Assist understands when you apply the brakes quickly but without the necessary force to maximise stopping performance. It therefore boosts the brake pressure through the ABS pump to ensure you stop in time.

To help reduce the risk of a collision, the Emergency Stop Signal system automatically activates the hazard warning lights during emergency braking.

Autonomous Emergency Braking – see page 28 for details.

To improve safety even further, two ISOFIX points for baby/child seat restraints are fitted on each side of the rear seats and a comprehensive system of six airbags including driver, passenger, side curtain and thorax airbags are standard to protect you.

For information on active safety features please refer to Driver Assistance pages 28 and 31.

Search 'Range Rover Velar Safety' for full details.

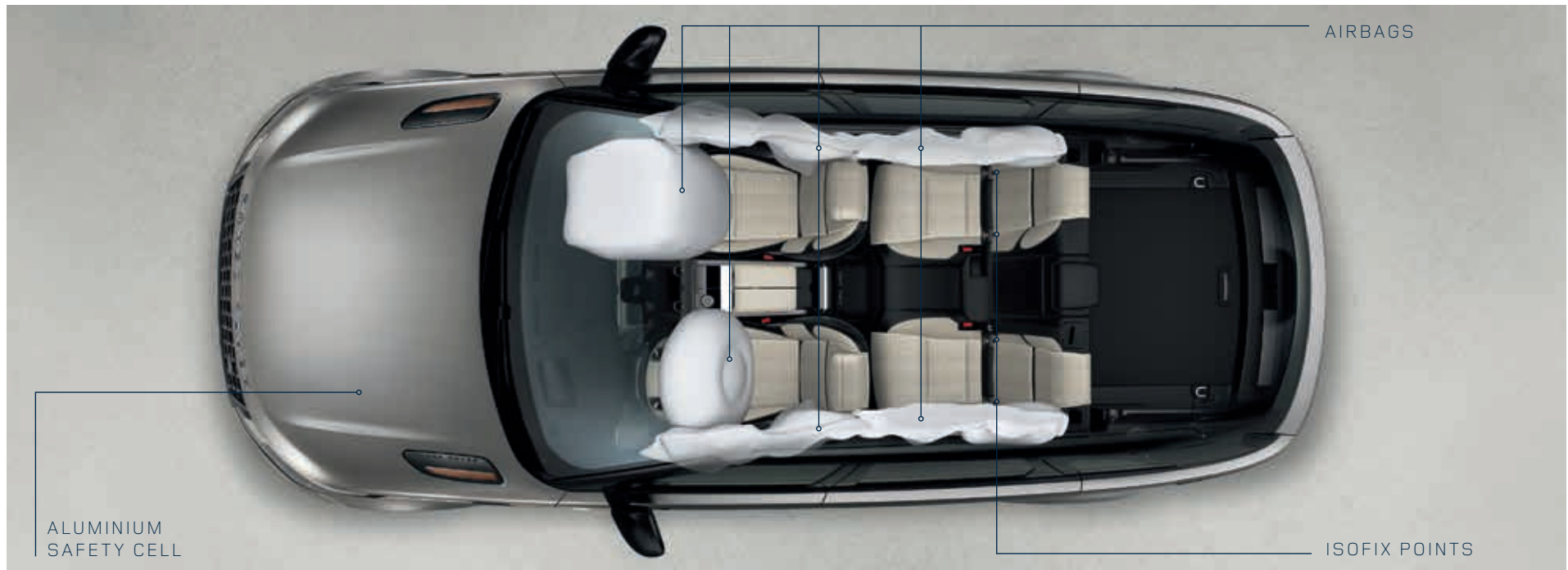



LED LOW BEAM 145M

BRIGHTER LIGHTS, SAFER NIGHT-TIME DRIVING

The Range Rover Velar features all-round exterior LED lighting as standard. LED lights are designed to last the lifetime of the vehicle and are more fuel-efficient as they use less energy. The quality of light produced is closer to daylight conditions, so driving at night becomes less tiring, and rear fog lights* help ensure the vehicle is visible in all conditions.

The higher optional levels of headlight feature the distinct exterior graphic of the Signature Daytime Running Lights (DRL's) and Animated Directional Indicators which reduce the time it takes other road users to recognise the intended direction of travel. When indicating, optional Static Cornering Lights** which operate at speeds less than 25mph, illuminate the road or driveway you are turning in to.

Driving at night or in poor visibility is made easier by the optional Auto High Beam Assist (AHBA) which detects lights ahead and automatically dips the main beam for oncoming traffic.

Optional Matrix LED headlights enable Intelligent High Beam Assist (IHBA) and Adaptive Front Lighting (AFL). By splitting the main beam into imperceptible vertical strips, the IHBA maximises the number of high beam sections around oncoming traffic for ultimate visibility, whilst casting a shadow in front of oncoming vehicles to prevent dazzling and for optimum safety. The AFL system optimises the lighting beam to suit a range of driving conditions: town, country, motorway and bad weather. Both systems work together to maximise visibility in all conditions.

Laser high beam technology provides the ultimate headlight option, delivering five times higher luminance than standard LED lights. Becoming operational above 50mph and when no other external lights are detected, the system produces clear sight for 550m.

Search 'Range Rover Velar Safety' for full details.



LED HIGH BEAM 330M

MATRIX-LASER LED 550M



	LED HEADLIGHTS	PREMIUM LED HEADLIGHTS WITH SIGNATURE DRL	MATRIX LED HEADLIGHTS WITH SIGNATURE DRL	MATRIX-LASER LED HEADLIGHTS WITH SIGNATURE DRL
Headlight powerwash	-	■	■	■
LED Headlights	■	■	■	■
Animated Directional Indicators	-	■	■	■
Auto High Beam Assist (AHBA)	-	■	-	-
Intelligent High Beam Assist (IHBA)	-	-	■	■
Adaptive Front Lighting (AFL)	-	-	■	■
Static Cornering Light	-	-	■	■
Laser High Beam	-	-	-	■

■ Standard - Not Available.



AIR SUSPENSION LOWERS BY 40MM

VERSATILITY

TRULY FLEXIBLE

Range Rover Velar enjoys optimum levels of space. Occupants can enjoy the highest levels of comfort and exemplary levels of stowage.

Automatic Access Height, as part of the optional Electronic Air Suspension*, allows you to get in and out of the vehicle with greater ease. When you arrive at your chosen destination and the ignition is switched off or the seat belts are unclipped, the vehicle lowers by an initial 10mm. Then, as you open the door, it drops to its full access height of 40mm lower, making exit – and entry – more relaxed and elegant. The ride height automatically returns to its normal height as you pull away.

Exceptional 970mm head clearance and 945mm knee clearance in the second row enables passengers to stretch out and relax. An optional electric recline function is also available for the rear seats, offering occupants in the second row additional comfort.

Optional Four-zone Climate Control helps make life more comfortable for everyone, by adjusting temperature levels, direction and intensity of airflow.

The 40:20:40 second row seat configuration features a rear-seat pass-through for stowage of skis, an armrest** and for the greatest possible storage space, the entire row can be folded. Optional Rear Seat Remote Release Levers are located in the luggage compartment and, when released, mechanically fold all the seats down. Even when you're heading off on an extended road trip, you don't have to compromise on space. With a maximum loadspace of 632 litres, you can carry several suitcases or other bulky items with ease.

*Standard on D300 and P380 engines. Optional on D240. **Armrest not available with 8-way manual seats. †Towing capacity 2,400kg with D180 and P250 engines.

Vehicle shown is R-Dynamic HSE in Silicon Silver with optional panoramic roof, Black contrast roof, privacy glass and 22" 9 split-spoke 'Style 9007' wheels with Diamond Turned finish.



5 SEATS
632 LITRES



4 SEATS
1,161 LITRES



3 SEATS
1,344 LITRES



2 SEATS
1,690 LITRES

A detachable tow bar with a towing capacity of 2,500kg[†] is available as an option. Alternatively, there is the option of an electrically deployable tow bar, stowed in the rear bumper, with a towing capacity of 2,500kg[†]. Both allow you to use items such as bike carriers from the range of Land Rover Gear, adding even more versatility to the vehicle. Everything has been designed and engineered for ease of use and adaptability, to fit perfectly with your lifestyle.

Search 'Range Rover Velar Versatility' for full details.



RANGE ROVER VELAR OFFERS AN EXCLUSIVE RANGE OF CHOICES THAT ALLOW YOU TO PERSONALISE YOUR VEHICLE.

The following pages take you through a logical series of steps to personalise your Range Rover Velar. You have a number of choices; from selecting your model and engine, to exterior and interior colours, wheels, finishes and those detailed touches that make the vehicle your own.

You can start with our online configurator at landrover.co.uk

42-45

1

**STEP 1
CHOOSE YOUR MODEL**

If you would like Land Rover designers to choose your Range Rover Velar features for you, turn to page 42 to see our First Edition.

If you would like to specify your own vehicle, turn to page 44 where you can compare the standard features across Range Rover Velar and Range Rover Velar R-Dynamic.

46-47

2

**STEP 2
CHOOSE YOUR ENGINE**

You can select from a range of powerful diesel or petrol engines.

48-49

3

**STEP 3
CHOOSE YOUR
SPECIFICATION PACK**

You can individualise your Range Rover Velar even further from a choice of superbly designed and engineered premium specification packs.

50-59

4

**STEP 4
CHOOSE YOUR EXTERIOR**

There's a wide range of exterior options to select from; roof styles, paint colours, exterior design packs and wheels – all enable you to truly express yourself.

60-69

5

**STEP 5
CHOOSE YOUR INTERIOR**

Once you've chosen your seat style, select your preferred colourway and choice of finishers.

70-77

6

**STEP 6
CHOOSE YOUR OPTIONS
AND LAND ROVER GEAR**

You can choose from a wealth of line-fit options to create the exact vehicle you require. A range of accessories which your retailer can fit is also available to select from.

78-79

TECHNICAL DETAILS

Technical information and data for dimensions, performance and specifications.

1

CHOOSE YOUR MODEL

SELECT FIRST EDITION



Flux Silver (Satin Finish)



Corris Grey



Silicon Silver

Range Rover Velar First Edition represents the epitome of the vehicle's design story. First Edition is only available in the first year of sales and includes the very finest touches and options as standard. It is presented in three exterior colours: Corris Grey, Silicon Silver or Flux Silver, a satin finish which is meticulously applied at our Special Vehicles Operations facility in Warwickshire, England.

Search 'Range Rover Velar First Edition' for full details.



**22" 9 SPLIT-SPOKE 'STYLE 9007'
WITH DIAMOND TURNED FINISH**

Standard on First Edition



**21" 5 SPLIT-SPOKE 'STYLE 5047'
WITH DIAMOND TURNED FINISH**

Optional on First Edition



**20" 10 SPOKE 'STYLE 1032'
WITH DIAMOND TURNED FINISH**

Optional on First Edition



First Edition includes all of the features available on R-Dynamic HSE (see page 49) plus the following:

PERFORMANCE AND CAPABILITY

Choose between the D300 or P380 engines. The attributes of each engine are provided on page 11 and 12.

The following performance features are standard:

- All Terrain Progress Control (ATPC)
- Terrain Response 2
- Configurable Dynamics
- Active Rear Locking Differential
- Wade Sensing

EXTERIOR

Select either the optional unique Satin exterior colour Flux Silver, optional Premium Metallic Silicon Silver or Metallic Corris Grey.

Select either the 22" 9 split-spoke 'Style 9007' with Diamond Turned finish or choose from one of the two additional optional wheels, the 20" 10 spoke 'Style 1032' with Diamond Turned finish or the 21" 5 split-spoke 'Style 5047' with Diamond Turned finish.

The following exterior features are standard:

- Exclusive First Edition badging on the B-pillar
- Black contrast roof
- Sliding panoramic roof
- Matrix-Laser LED headlights with Signature Daytime Running Lights (DRL)
- Privacy glass

INTERIOR

The following interior features are standard:

- 20-way heated/cooled front seats with memory and massage settings and heated rear reclining seats
- Light Oyster/Ebony perforated Windsor leather
- Unique Carbon Fibre with Copper Wire Weave trim finishes with exclusive First Edition script
- Suedecloth headlining
- Illuminated front treadplates
- Premium carpet mats
- Configurable Ambient Interior Lighting
- Heated steering wheel
- Head-up Display
- Meridian™ Signature Sound System with 23 speakers
- Power Socket Pack 2 – 4 x USB, 3 x 12V
- Instrument panel chrome ends
- Reduced section alloy spare wheel
- Interior Luxury Pack Plus
- Surround Camera System
- Activity Key



When you have selected your preferred engine, colour and wheels, visit pages 70-77 to choose from our wide range of Land Rover Gear.

SELECT RANGE ROVER VELAR OR RANGE ROVER VELAR R-DYNAMIC

To help you choose between the Range Rover Velar or Range Rover Velar R-Dynamic models, this guide provides the standard features across both models, plus the additional features you will get should you select Range Rover Velar R-Dynamic.

Range Rover Velar's elegant proportions and unmistakable Range Rover design cues create a vehicle that simply demands attention.

STANDARD FEATURES

TRANSMISSION AND DYNAMICS

- Single-speed transfer box
- Electric Parking Brake (EPB)
- 8-speed Automatic Transmission
- Terrain Response
- Anti-Lock Braking System (ABS)
- Adaptive Dynamics
- Torque Vectoring by Braking
- Hill Descent Control (HDC)
- Hill Launch Assist
- Gradient Release Control (GRC)
- Electronic Traction Control (ETC)
- Dynamic Stability Control (DSC)
- Cornering Brake Control (CBC)
- Lane Departure Warning
- Electronic Brake-force Distribution (EBD)
- Roll Stability Control (RSC)
- Speed Proportional Electronic Power Assisted Steering (EPAS)
- Low Traction Launch
- Coil suspension
- Electronic Air Suspension*
- Stop/Start
- Trailer Stability Assist (TSA)

EXTERIOR FEATURES AND FINISH

- Rain sensing wipers
- Tailgate slotted spoiler
- Flush deployable door handles
- Heated exterior mirrors
- Solid paint
- Acoustic laminated windscreen
- Heated windscreen

HEADLIGHTS AND LIGHTING

- Automatic headlights
- Follow me home lighting
- Rear fog lights
- Front and rear LED lights

WHEELS AND OPTIONS

- Tyre Pressure Monitoring System (TPMS)
- 18" 15 spoke 'Style 1022'
- Reduced Section Steel Spare Wheel
- All season tyres

INTERIOR FEATURES

- Touch Pro Duo
- Sunvisors with illuminated vanity mirrors
- Push Button Start
- Morzine headlining
- Painted door finishers
- Leather steering wheel
- Analogue Dials with 5" TFT Display
- Black gearshift paddles
- Metal loadspace scuff plate and metal front treadplates
- Two-zone Climate Control
- Ambient Interior Lighting
- Bluetooth® connectivity
- Air Quality Sensor
- Auto-dimming interior rear view mirror
- Land Rover Sound System 250W with 8 speakers
- InControl Remote
- Carpet mats
- DAB radio

SEATING FUNCTIONALITY

- Luxtec and suedecloth seats
- 8-way manual seats with heated front
- Two piece sliding front centre armrest
- 40:20:40 split fold rear seat
- Second row centre headrest

CONVENIENCE

- Keyless Entry
- Rear Parking Aid
- Cruise Control with Speed Limiter
- Manual tailgate
- Loadspace cover
- Voice Control
- Power Socket Pack 1 – 2 x USB, 3 x 12V
- Lockable glovebox
- Electric windows with one-touch open/close and anti-trap

SAFETY

- Intrusion sensor
- Advanced Emergency Brake Assist
- Autonomous Emergency Braking
- 325mm front brakes
- 350mm front brakes**
- Brake pad wear indicator
- 6 airbags
- Seat belt reminder
- Rear ISOFIX
- Power operated child locks

*Standard on D300 and P380 engines. Optional on all other engines. **Standard on D300 and P380. Optional on all other engines. †Only available on D300 and P380 engines.

RANGE ROVER VELAR



RANGE ROVER VELAR R-DYNAMIC S



Range Rover Velar R-Dynamic has a purposeful stance with Burnished Copper bumper accents, bonnet vents and side vents adding greatly to its sophisticated contemporary look and allure. The bonnet badge, tailgate script and grille are finished in Shadow Atlas whilst inside, the vehicle features Satin Chrome gearshift paddles and Bright metal pedals to enhance the sportier feel.

R-DYNAMIC S FEATURES
IN ADDITION TO
STANDARD FEATURES:

- R-Dynamic treadplates
- Leather steering wheel with Satin Chrome bezel
- Unique front and rear bumper design including integrated exhaust finishers*
- Satin Chrome gearshift paddles
- Shadow Aluminium trim finisher
- Bright metal pedals
- Ebony Morzine headlining
- Gloss Black mirrors with Narvik Black scalps
- Front fog lights
- 19" 5 spoke 'Style 5046' with Satin Dark Grey finish wheels
- Perforated grained leather seats with suedecloth bolsters

2

CHOOSE YOUR ENGINE

You can choose from five powertrains: three of which are diesel and two petrol. Range Rover Velar delivers effortless performance from its advanced line-up of refined and fuel-efficient diesel and petrol engines, which are paired with a smooth and responsive 8-speed Automatic Transmission.

DRIVELINE, ENGINE PERFORMANCE AND FUEL ECONOMY

	DIESEL			
	AUTOMATIC	AUTOMATIC	AUTOMATIC	
	D180*	D240	D300	
POWER (HP)				
Driveline	All Wheel Drive (AWD)	All Wheel Drive (AWD)	All Wheel Drive (AWD)	
Maximum power hp (kW)/rpm	180 (132)/4,000	240 (177)/4,000	300 (221)/4,000	
Maximum torque (Nm/rpm)	430/1,500	500/1,500	700/1,500	
Capacity (cc)	1,999	1,999	2,993	
No. of cylinders	4	4	6	
Cylinder layout	In-line	In-line	Longitudinal V6	
PERFORMANCE				
Maximum speed	mph (km/h)	130 (209)	135 (217)	150 (241)
Acceleration (seconds)	0-60mph (0-100 km/h)	8.4 (8.9)	6.8 (7.3)	6.1 (6.5)
FUEL ECONOMY				
Combined	mpg (l/100km)	From 52.5 (5.4)	From 48.7 (5.8)	From 44.1 (6.4)
CO ₂ Combined emissions	g/km	From 142	From 154	From 167

*If vehicle is fitted with 18" wheels the top speed will be 120mph.

Official EU test figures. For comparison purposes only. Real world figures may differ. Low fuel warning at 9 litres approximately.

DRIVE, ENGINE PERFORMANCE AND FUEL ECONOMY

	PETROL	
	AUTOMATIC	AUTOMATIC
	P250	P380
POWER (HP)		
Driveline	All Wheel Drive (AWD)	All Wheel Drive (AWD)
Maximum power hp (kW)/rpm	250 (184)/5,500	380 (280)/6,500
Maximum torque (Nm/rpm)	365/1,200	450/3,500
Capacity (cc)	1,997	2,995
No. of cylinders	4	6
Cylinder layout	In-line	Longitudinal V6
PERFORMANCE		
Maximum speed	mph (km/h)	135 (217)
Acceleration (seconds)	0-60mph (0-100 km/h)	6.4 (6.7)
FUEL ECONOMY		
Combined	mpg (l/100km)	From 37.2 (7.6)
CO ₂ Combined emissions	g/km	From 173



3

CHOOSE YOUR SPECIFICATION PACK

This guide will help you select your ideal Range Rover Velar. No matter which model you choose, the standard specification Range Rover Velar, through to one of the three Specification Packs; S, SE or HSE – you can always select additional options from those featured on page 70 to make your vehicle even more individual*.

S



SE



HSE



R-DYNAMIC – S



R-DYNAMIC – SE



R-DYNAMIC – HSE



	S	SE	HSE
WHEELS	<ul style="list-style-type: none"> - 19" 5 spoke 'Style 5046' <p>When R-Dynamic is specified:</p> <ul style="list-style-type: none"> - 19" 5 spoke 'Style 5046' with Satin Dark Grey finish 	<ul style="list-style-type: none"> - 20" 7 spoke 'Style 7014' <p>When R-Dynamic is specified:</p> <ul style="list-style-type: none"> - 20" 10 spoke 'Style 1032' with Satin Dark Grey finish 	<ul style="list-style-type: none"> - 21" 5 split-spoke 'Style 5047' <p>When R-Dynamic is specified:</p> <ul style="list-style-type: none"> - 21" 10 spoke 'Style 1033' with Satin Dark Grey finish
VISION	<ul style="list-style-type: none"> - Premium LED headlights with Signature Daytime Running Lights (including power wash) 	<ul style="list-style-type: none"> - Matrix LED headlights with Signature Daytime Running Lights (including power wash) 	<ul style="list-style-type: none"> - Matrix LED headlights with Signature Daytime Running Lights (including power wash)
POWERED CONVENIENCE	<ul style="list-style-type: none"> - Powered Gesture Tailgate - Auto-dimming, power fold, heated door mirrors with approach lights 	<ul style="list-style-type: none"> - Powered Gesture Tailgate - Auto-dimming, power fold, heated door mirrors with approach lights 	<ul style="list-style-type: none"> - Powered Gesture Tailgate - Auto-dimming, power fold, heated door mirrors with approach lights - Electrically adjustable steering column
SEATING	<ul style="list-style-type: none"> - Perforated grained leather seats - 10-way seats with driver memory and heated front (including rear armrest and power recline) <p>When R-Dynamic is specified:</p> <ul style="list-style-type: none"> - Perforated grained leather seats with suedecloth bolsters 	<ul style="list-style-type: none"> - Perforated grained leather seats - 10-way seats with driver memory and heated front (including rear armrest and power recline) <p>When R-Dynamic is specified:</p> <ul style="list-style-type: none"> - Perforated grained leather seats with suedecloth bolsters 	<ul style="list-style-type: none"> - Perforated Windsor leather seats - 20-way seats with driver/passenger memory massage and heated/cooled front (including rear armrest and power recline) - Leather steering wheel and airbag cover** with Satin Chrome bezel - Satin Chrome gearshift paddles - Interior Luxury Pack includes: Windsor leather door top roll lower, Windsor leather mid instrument panel
INFOTAINMENT	<ul style="list-style-type: none"> - Smartphone Pack - Pro Services and Wi-Fi Hotspot - Navigation Pro - Meridian™ Sound System 380W with 11 speakers 	<ul style="list-style-type: none"> - Smartphone Pack - Pro Services and Wi-Fi Hotspot - Navigation Pro - Meridian Surround Sound System 825W with 17 speakers - Interactive Driver Display 	<ul style="list-style-type: none"> - Smartphone Pack - Pro Services and Wi-Fi Hotspot - Navigation Pro - Meridian Surround Sound System 825W with 17 speakers - Interactive Driver Display
DRIVING AIDS	<ul style="list-style-type: none"> - Rear View Camera 	<ul style="list-style-type: none"> - Rear View Camera - Drive Pack consisting of; Blind Spot Monitor, Driver Condition Monitor and Traffic Sign Recognition and Adaptive Speed Limiter - Park Pack consisting of; 360° Parking Aid and Reverse Traffic Detection 	<ul style="list-style-type: none"> - Rear View Camera - Drive Pro Pack consisting of; Adaptive Cruise Control with Queue Assist and Intelligent Emergency Braking, Lane Keep Assist, Blind Spot Assist, Driver Condition Monitor and Traffic Sign Recognition and Adaptive Speed Limiter - Park Pro Pack consisting of; Park Assist (includes 360° Parking Aid) and Reverse Traffic Detection

**Inner steering wheel rim and airbag cover matches specified interior trim.

4

CHOOSE YOUR EXTERIOR

SELECT YOUR ROOF

Choose from an optional sliding panoramic or fixed panoramic roof, both of which enhance the sense of space in the vehicle's interior and flood it with natural light. The fixed panoramic roof provides uninterrupted views of the surrounding environment. The sliding panoramic roof opens to let the outside in. You can also select either body-coloured or Black contrast roof to further enhance your vehicle's exterior.



Body-coloured Roof (Standard)



Body-coloured Fixed Panoramic Roof (Optional)



Body-coloured Sliding Panoramic Roof (Optional)



Black Contrast Roof* (Optional)



Black Contrast Fixed Panoramic Roof* (Optional)



Black Contrast Sliding Panoramic Roof* (Optional)

SELECT YOUR PAINT COLOUR

Now you have chosen your preferred roof style, you can select your exterior paint colour. From rich, deep lustres to smooth, crisp metallics, our paints incorporate the latest in pigment technologies. Our solid paints produce a deep flat colour. Our optional metallics deliver a sparkle finish that is sure to catch the eye. And our optional premium metallic paints further enhance the exterior form through the intensity of the liquid like smoothness to give your vehicle even more presence.



Fuji White (Solid)



Narvik Black* (Solid)



Indus Silver (Metallic)



Corris Grey (Metallic)



Firenze Red (Metallic)



Byron Blue (Metallic)



Aruba (Premium Metallic)



Yulong White (Metallic)



Kaikoura Stone (Metallic)



Carpathian Grey (Premium Metallic)



Santorini Black* (Metallic)



Silicon Silver (Premium Metallic)

SELECT BETWEEN RANGE ROVER VELAR DESIGN PACKS

You can tailor the exterior of your Range Rover Velar with the addition of any of the following packs: Premium Exterior Pack, Black Exterior Pack and Premium Black Exterior Pack. Each one elevates the vehicle's sense of sophistication, with specific detailing providing another level of individuality. Please note that these packs are not available on R-Dynamic models. Instead, for the Range Rover Velar R-Dynamic model, the R-Dynamic Black Pack is available. See pages 56 and 57.

STANDARD RANGE ROVER VELAR



Atlas grille inner surround
Atlas grille mesh
Satin Black lower blade
Satin Black lower finisher
Satin Black front bumper lower



Satin Black pinstripe finisher
Atlas fender vents



Dark Techno Silver tow eye cover surround
Atlas RANGE ROVER bonnet and tailgate script

PREMIUM EXTERIOR PACK



Narvik Black mid finisher
Atlas lower blade
Narvik Black lower finisher
Front fog lights



Narvik Black pinstripe finisher*
Narvik Black door cladding lower*
Narvik Black front bumper lower*



Narvik Black rear bumper lower*
Indus Silver tow eye cover surround
Narvik Black tow eye cover*

BLACK EXTERIOR PACK



Narvik Black grille inner surround
Narvik Black grille mesh
Narvik Black lower blade

Gloss Black mirror lowers with
Narvik Black scalp
Narvik Black side vents and door
finisher blade

Narvik Black tow eye cover surround
Narvik Black tow eye cover
Narvik Black RANGE ROVER bonnet
and tailgate script

PREMIUM BLACK EXTERIOR PACK



Narvik Black lower blade
Narvik Black mid finisher
Narvik Black lower finisher
Front fog lights

Narvik Black pinstripe finisher
Narvik Black door cladding lower
Narvik Black front bumper lower

Narvik Black tow eye cover surround
Narvik Black tow eye cover
Narvik Black RANGE ROVER bonnet
and tailgate script
Narvik Black rear bumper lower



SELECT THE RANGE ROVER VELAR R-DYNAMIC BLACK PACK

The R-Dynamic Black Pack provides the most superb enhancement to the Range Rover Velar R-Dynamic's undoubted sporty look. It is available in all exterior paint colours and includes Narvik Black grille mesh, bonnet vent blades, bonnet script and tailgate script.



Narvik Black grille mesh
Narvik Black grille inner surround
Narvik Black RANGE ROVER bonnet and tailgate script
Narvik Black lower blade



Narvik Black bonnet vent blades
Narvik Black air curtain inserts



Narvik Black side vents and door finisher blade
Gloss Black mirror lowers with Narvik Black scalps



Narvik Black exhaust finishers*
Narvik Black tow eye cover surround

*Only available with D300 and P380 engines.

Vehicle shown is R-Dynamic P380 HSE in Silicon Silver with optional panoramic roof, Black contrast roof, privacy glass and 22" 9 split-spoke 'Style 9007' wheels with Diamond Turned finish.

SELECT YOUR WHEELS

There are 18 wheel styles to choose from, all of which are available on every model. Sizes range from 18" to the highly desirable 22". With distinctive design cues, each one adds its own character to the overall look of the vehicle.



18" 10 SPOKE
'STYLE 1021'



18" 15 SPOKE
'STYLE 1022'

Standard on Range Rover Velar



19" 5 SPOKE
'STYLE 5046'

Standard on Range Rover Velar S



19" 5 SPOKE 'STYLE 5046'
WITH SATIN DARK GREY FINISH

Standard on Range Rover Velar
R-Dynamic S



20" 7 SPLIT-SPOKE
'STYLE 7014'

Standard on Range Rover Velar SE



20" 7 SPLIT-SPOKE 'STYLE 7014'
WITH GLOSS BLACK FINISH



20" 10 SPOKE
'STYLE 1032'



20" 10 SPOKE 'STYLE 1032'
WITH SATIN DARK GREY FINISH

Standard on Range Rover Velar
R-Dynamic SE



20" 10 SPOKE 'STYLE 1032'
WITH DIAMOND TURNED FINISH



21" 5 SPLIT-SPOKE
'STYLE 5047'

Standard on Range Rover Velar HSE



21" 5 SPLIT-SPOKE 'STYLE 5047'
WITH DIAMOND TURNED FINISH



21" 10 SPOKE 'STYLE 1033'
WITH GLOSS BLACK FINISH



21" 10 SPOKE 'STYLE 1033'
WITH SATIN DARK GREY FINISH
Standard on Range Rover Velar
R-Dynamic HSE



22" 7 SPLIT-SPOKE
'STYLE 7015'



22" 7 SPLIT-SPOKE 'STYLE 7015'
WITH GLOSS BLACK FINISH



22" 9 SPLIT-SPOKE
'STYLE 9007'



22" 9 SPLIT-SPOKE 'STYLE 9007'
WITH DIAMOND TURNED FINISH



22" 10 SPOKE 'STYLE 1051'
WITH DIAMOND TURNED SATIN
TECHNICAL GREY FINISH*

5

CHOOSE YOUR INTERIOR

SELECT YOUR SEAT MATERIAL AND FUNCTIONALITY

Seats are available in a choice of five different premium materials, with a range of manual and powered operation including: optional memory, heating, cooling and massage functionality. The seat materials include Luxtec and suedecloth, perforated grained leather, perforated grained leather and suedecloth, perforated Windsor leather and an all-new premium textile and suedecloth seat – available as an option on all derivatives.

FUNCTIONALITY	A – 8-way seats	B – 10-way seats	C – 10-way seats with driver memory	D – 18-way seats with driver/passenger memory	E - 20-way seats with driver/passenger memory*
MOVEMENT					
Forward/Backward	Manual (2)	Powered (2)	Powered (2)	Powered (2)	Powered (2)
Cushion height	Manual (2)	Powered (2)	Powered (2)	Powered (2)	Powered (2)
Cushion tilt		Powered (2)	Powered (2)	Powered (2)	Powered (2)
Cushion extension				Powered (2)	Powered (2)
Recline	Manual (2)	Powered (2)	Powered (2)	Powered (2)	Powered (2)
Lumbar				Powered (4)	Powered (4)
Bolsters				Powered (2)	Powered (2)
Headrest height	Manual (2)	Manual (2)	Manual (2)	Manual (2)	Powered (2)
Manual winged headrest					Manual (2)
FEATURES					
Driver memory	–	–	■	■	■
Passenger memory	–	–	–	■	■
Heated front	■	■	■	–	–
Heated and cooled front	–	–	□	■	■
Massage front	–	–	–	■	■
Heated rear	□	□	□	□	□
Rear centre armrest	–	■	■	■	■
Rear power recline	–	–	■	■	■

■ Standard □ Optional – Not Available.



Luxtec and suedecloth



Perforated grained leather

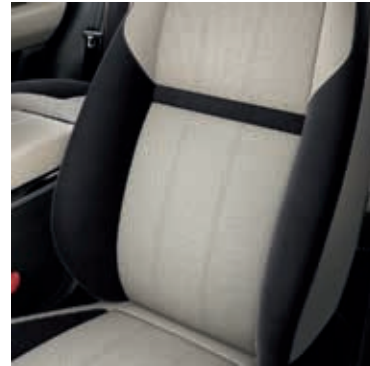





Perforated grained leather and suedecloth



Perforated Windsor leather**

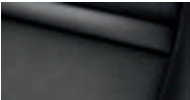

Premium textile and suedecloth†

SEAT MATERIAL	A	B	C	D	E
 <p>Luxtec and suedecloth: Technically advanced, Luxtec is a smooth soft touch material which is complemented by suedecloth. This is a sustainable, lightweight, premium microfibre suede fabric made from recycled materials.</p>	■	□	–	–	–
 <p>Perforated grained leather: Grained leather is embossed with a natural robust leather grain which makes it both durable and easy on the eye.</p>	–	–	■	–	–
 <p>Perforated grained leather and suedecloth: Grained leather is embossed with a natural robust leather grain which makes it both durable and easy on the eye. This is matched by suedecloth which is an eco-sustainable, lightweight, premium microfibre suede fabric made from recycled materials.</p>	–	–	■	–	–
 <p>Perforated Windsor leather**: Smooth in appearance and extremely supple to the touch, Windsor leather is made using high-grade hides and minimal processing. It has a light dye coating so is a more natural product.</p>	–	–	–	□	■
 <p>Premium textile and suedecloth†: A premium, contemporary textile developed in collaboration with Europe's leading quality upholstery textiles manufacturer, Kvadrat. This material is an exceptional new option.</p>	–	–	–	□	■

■ Standard □ Optional – Not Available.

SELECT YOUR INTERIOR COLOUR COMBINATION

A calm sanctuary. That's how it feels to be in the cabin of Range Rover Velar where the choice of materials, finishers and craftsmanship all combine so effortlessly.

Use the table below to select your colour combinations. Or see the full range in greater detail on pages 63-65.



		1	2	3	4	5
COLOURWAYS*		DOOR ARMREST AND DOOR ROLL LOWER	DOOR ROLL UPPER	INSTRUMENT PANEL UPPER	CUBBY BOX	MID INSTRUMENT PANEL
(A) Ebony		Ebony	Ebony	Ebony	Ebony	Ebony
(B) Acorn		Acorn	Ebony	Ebony	Acorn	Acorn
(C) Light Oyster		Light Oyster	Ebony	Ebony	Light Oyster	Light Oyster
(D) Ebony/Ebony*		Ebony	Ebony	Ebony	Ebony	Ebony
(E) Light Oyster/Ebony*		Light Oyster	Ebony	Ebony	Light Oyster	Light Oyster
(F) Eclipse/Ebony*		Eclipse	Ebony	Ebony	Eclipse	Eclipse
(G) Vintage Tan/Ebony*		Vintage Tan	Ebony	Ebony	Vintage Tan	Vintage Tan
(H) Dapple Grey/Ebony		Dapple Grey/Ebony	Ebony	Ebony	Dapple Grey	Ebony
(I) Dapple Grey/Light Oyster		Dapple Grey/Light Oyster	Ebony	Ebony	Dapple Grey	Light Oyster

*Colourway availability varies by seating material.

INTERIOR COLOUR COMBINATIONS

The colour combinations add to that sense of serenity with a comprehensive range on offer to suit all tastes. Colour combinations shown are available on all models, please check the table on pages 60 and 61 for seat functionality and material availability.

- A Ebony**
(available with Luxtec and suedecloth, perforated grained leather or perforated Windsor leather)



Interior shown: SE interior in Ebony with Ebony perforated grained leather and Shadow Aluminium finisher.

- B Acorn**
(available with perforated grained leather or perforated Windsor leather)



Interior shown: SE interior in Acorn with Acorn perforated grained leather and Satin Umber Linear veneer.

- C Light Oyster**
(available with perforated grained leather or perforated Windsor leather)



Interior shown: SE interior in Light Oyster with Light Oyster perforated grained leather and Argento Pinstripe High Gloss veneer.

D Ebony/Ebony
(available with perforated grained leather and suedecloth)



Interior shown: R-Dynamic SE interior in Ebony/Ebony with Ebony perforated grained leather and suedecloth and Carbon Fibre with Copper Wire Weave finisher.

E Light Oyster/Ebony
(available with perforated grained leather and suedecloth or perforated Windsor leather)



Interior shown: R-Dynamic SE interior in Light Oyster/Ebony with Light Oyster perforated grained leather and Ebony suedecloth and Carbon Fibre with Copper Wire Weave finisher.

F Eclipse/Ebony
(available with perforated grained leather and suedecloth or perforated Windsor leather)



Interior shown: R-Dynamic SE interior in Eclipse/Ebony with Eclipse perforated grained leather and Ebony suedecloth and Carbon Fibre with Copper Wire Weave finisher.

G Vintage Tan/Ebony
(available with perforated Windsor leather)



Interior shown: R-Dynamic HSE interior in Vintage Tan/Ebony with Vintage Tan/Ebony perforated Windsor leather, Carbon Fibre with Copper Wire Weave finisher and Full Extended Leather Upgrade.

PREMIUM TEXTILES

Range Rover Velar offers a fresh alternative to leather; contemporary and beautifully crafted textiles. In partnership with the world-renowned designers and craftspeople at Kvadrat, durable wool blend and suedecloth fabrics can be selected in a choice of colourways*. Tested to the limits, these technologically advanced textiles are a superb alternative to leather and are available in all models.

H Dapple Grey/Ebony

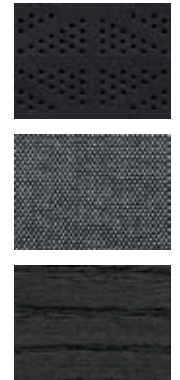

Interior shown: R-Dynamic HSE interior in Dapple Grey/Ebony with Dapple Grey premium textile and Ebony suedecloth and Satin Charcoal Ash veneer.

I Dapple Grey/Light Oyster

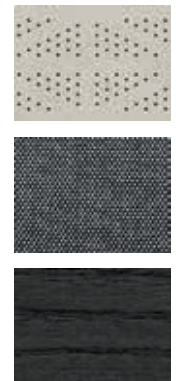

Interior shown: R-Dynamic HSE interior in Dapple Grey/Light Oyster with Dapple Grey premium textile and Light Oyster suedecloth and Satin Charcoal Ash veneer.

*Only available when the Premium Textile Interior Pack is selected.

SELECT YOUR INTERIOR FINISHERS

Now you've chosen your interior colour combination, choose one of eight interior finishers that are beautifully displayed above the door armrests, indicated by the number 1 below.



STANDARD

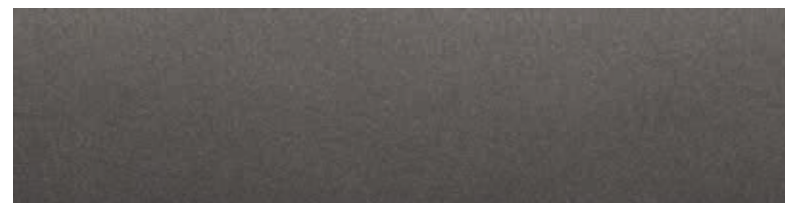

Range Rover Velar – Cosmic Grey finisher

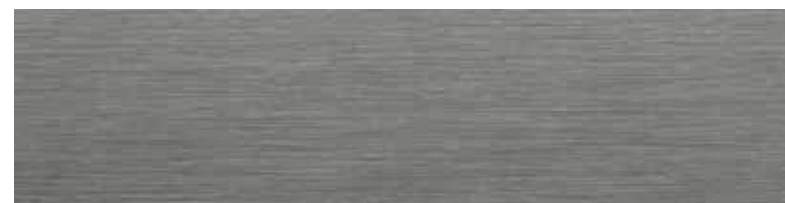

Range Rover Velar R-Dynamic – Shadow Aluminium finisher*

OPTIONAL



Satin Blonde Linear veneer



Satin Charcoal Ash veneer

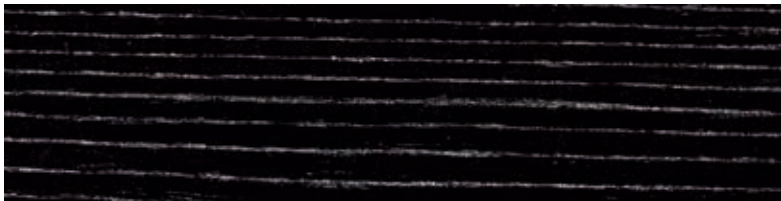

Argento Pinstripe High Gloss veneer



Satin Umber Linear veneer



Grand Black veneer



Carbon Fibre with Copper Wire Weave finisher

SELECT AN INTERIOR DESIGN PACK

To add additional touches of individuality, sophistication and comfort to your cabin space, you can choose from three interior design packs.

R-DYNAMIC S



As standard the Range Rover Velar R-Dynamic S model includes perforated grained leather seats with suedecloth bolsters, Cut Diamond grain Luxtec on the mid instrument panel and door top roll lowers. A Leather steering wheel with Satin Chrome bezel and Satin Chrome gearshift paddles is also included.

LUXURY PACK*



Windsor leather on the mid instrument panel and door top roll lowers.
Leather steering wheel with Satin Chrome bezel** and Satin Chrome gearshift paddles.

LUXURY PACK PLUS*



Windsor leather on the mid instrument panel, instrument panel topper, door top roll uppers and lowers.
Leather steering wheel with Satin Chrome bezel** and Satin Chrome gearshift paddles.

PREMIUM TEXTILE PACK



Premium textile seats with wool blend and suedecloth.
Cut Diamond grain Luxtec on the mid instrument panel and door top roll lowers.
Suedecloth steering wheel with Satin Chrome bezel and Satin Chrome gearshift paddles.
In addition auto-dimming, power fold, heated door mirrors with approach lights complete the pack.

6

CHOOSE YOUR OPTIONS AND LAND ROVER GEAR

SELECT YOUR OPTIONS

A wealth of line-fit options are available to select from at the point of ordering your new vehicle, to help you express your individuality and appoint your Range Rover Velar with precisely the premium features you require.

For full feature and option availability please refer to the accompanying Specification and Price Guide or visit your local Land Rover Retailer.

EXTERIOR FEATURES

Roof Rails

Line-fit roof rails facilitate easy fitment of cross bars for truly stable roof carrying. Pre-set positioning points ensure cross bars are fixed in optimum position for weight distribution and dynamics. Available in Black or Silver finishes. Not available as Land Rover Gear – Accessories fit.

No Badges

You have the option to remove both the derivative and engine badges from the rear of the vehicle.

Privacy Glass

Provides privacy for rear passengers by restricting vision into the rear cabin.

Auto-Dimming, Power Fold, Heated Door Mirrors with Approach Lights*

These advanced, heated mirrors are power folding to avoid damage when parking in confined spaces. In addition, the door mirror features auto-dipping functionality when the reverse gear is selected, improving visibility when manoeuvring. Integrated approach lights to the underside of the mirrors feature the Range Rover Velar silhouette. The mirrors are also equipped with a memory function when combined with memory seats. Once you set your ideal seating and mirror positions, it automatically recalls your preferred driving position settings.

Solar Attenuating Windscreen

This windscreen filters sunlight to reduce heat, and prevent UV rays from entering the cabin.

Fixed or Sliding Panoramic Roof

See page 11 for details.

Premium LED Headlights with Signature Daytime Running Lights (DRL)

See page 36 for details.

Matrix LED Headlights with Signature DRL (includes Adaptive Front Lighting System and Intelligent High Beam Assist)

See page 36 for details.

Matrix-Laser LED Headlights with Signature DRL (includes Adaptive Front Lighting System and Intelligent High Beam Assist)

See page 36 for details.

Powered Gesture Tailgate

Powered Gesture Tailgate enables the driver to operate the tailgate (both to open and close) from the kerbside without needing to physically touch either the vehicle or the key fob. And as the system is compatible with accessory towing solutions, you can still tackle demanding situations with the least amount of fuss.



Roof Rails



Powered Gesture Tailgate

TYRES AND SPARE WHEELS

Summer Tyres

Summer tyres are optional on all wheel sizes except 18". Load index and speed ratings dependent on wheel sizes.

Full Size Spare Wheel

When full size spare wheel is selected, the loadspace floor height raises approximately by 10cm. Includes tool kit.

Reduced Section Alloy Spare Wheel

Lightweight reduced section alloy spare wheel. Includes tool kit.

DRIVING AIDS

350mm Front Brakes

The greater thermal mass of the 350mm front brakes improves resistance to brake fade.

Configurable Dynamics

See page 15 for details.

Electronic Air Suspension

See page 17 for details.

All Terrain Progress Control (ATPC)

See page 17 for details.

Terrain Response 2

See page 18 for details.

Wade Sensing

See page 18 for details.

Active Rear Locking Differential

See page 19 for details.

Drive Features

See page 28 for details.

Park Features

See page 30 for details.



Full Size Spare Wheel



Wade Sensing

SEATING AND INTERIOR TRIM

Rear Seat Remote Release Levers

Remote release of the rear seats via levers in the loadspace area makes folding the rear seats for additional loading capacity even easier.

Premium Carpet Mats

800gsm twistpile Ebony floor mats with metal Range Rover Velar ingot protect your vehicle in exclusive style. They feature Ebony suede effect binding and single Ebony stitching.

Chrome Instrument Panel End Caps*

Chrome IP end caps that finish the instrument panel.

Electrically Adjustable Steering Column

This feature allows electrical adjustment of the steering column's reach and rake. Adjustment memory is linked to seat positioning if memory seats are taken.

Heated Steering Wheel

For the ultimate driver comfort in colder climates, a heated leather steering wheel is available.

Suedecloth Steering Wheel

An all-new suedecloth steering wheel with Satin Chrome bezel and gearshift paddles is available. This gives you a better grip, is warmer in the cold and doesn't get hot in the sun's glare. Added to which, the material feels soft to the touch and looks superb.

Leather Steering Wheel with Chrome Bezel

Leather steering wheel with beautifully integrated Chrome bezel, perforation in the inner rim and thumb grips for better comfort and grip.

Illuminated Metal Loadspace Scuff Plate

Elegantly styled rear loadspace scuff plate illuminated by soft blue lighting when the tailgate is opened. It protects the loadspace edge from scratches when loading and unloading. Not compatible with full size spare wheel.

Illuminated Metal Front and Metal Rear Treadplates**

Illuminated aluminium treadplates, featuring Range Rover or R-Dynamic script are available on driver and front passenger sides.

Morzine Headlining

Woven cloth headlining available in Light Oyster or Ebony.

Suedecloth Headlining

Premium suedecloth headlining option available in Light Oyster or Ebony.



Illuminated Metal Front and Metal Rear Treadplates**

INTERIOR FEATURES AND PACKS

Satin Chrome Gearshift Paddles†

Complete the look and feel of your steering wheel with premium paddles. Gearshift paddles are finished in Satin Chrome to provide exceptional wear resistance with a premium finish.

Configurable Ambient Interior Lighting

This feature allows you to vary the colour and shade, changing the ambience of the cabin to suit your mood. There are ten colours in total.

Lockable Cooled Glovebox

Cooled glovebox gives the option to vent the cooled air from the air conditioning system entering the cabin into the glovebox.

Four-zone Climate Control

This system provides separate controls for the driver, front passenger and those on each side of the second row of seats. Includes additional vents in the B-pillar. Must be selected with Lockable Cooled Glovebox.

Cabin Air Ionisation

This technology helps the wellbeing of both driver and passengers alike. It improves the air quality within the vehicle cabin, removes allergens, any viruses, airborne bacteria and associated odours. It does so by ionising particles in the air, making them attract to surfaces and thus helping to cleanse the air. It can be switched on or off.

Timed Climate with Remote

This pre-heats the engine, channelling residual heat into the cabin, so the vehicle is warm and comfortable by the time you leave the house. It has an integrated 7-day timer. It can be used daily or a single event up to 16 days ahead.

Loadspace Partition Net

Designed to protect vehicle occupants against the displacement of luggage. Following initial retailer installation the luggage partition can be easily removed with appropriate fitting tool. Complies with ECE-17 regulation.

Loadspace Storage Rails

Loadspace rails extend and adjust to secure items. Not compatible with full size spare wheel.

Smoker's Pack

Add a lighter socket and ashtray to the centre console.

On/Off Road Pack

This adds Terrain Response 2, All Terrain Progress Control (ATPC) and Configurable Dynamics to assist driving on a variety of surfaces.

Climate Pack

This includes the Four-zone Climate Control, Cabin Air Ionisation and Lockable Cooled Glovebox.

Convenience Pack

This offers Activity Key, Rear Seat Remote Release Levers and the Loadspace Partition Net.

CONVENIENCE AND INFOTAINMENT

Activity Key

Makes living life to the full even easier. For extra convenience, you can wear the Activity Key if you prefer not to carry a key fob. The wristband is robust and fully waterproof. It allows you to enjoy a range of activities – and keep your vehicle key with you. You can use the Activity Key while keys remain in the vehicle as the conventional key fob is deactivated for security.

HomeLink®

The HomeLink® System is a universal transmitter fitted to the underside of the interior rear view mirror. This transmitter can be programmed to operate up to 3 home or office wireless controlled systems, such as garage doors, automatic gates, or security lighting. By replacing the individual remote control units normally required for each system, the driver no longer needs to search the vehicle interior for the correct handset when needed.

8" Rear Seat Entertainment

See page 21 for details.

Digital TV

See page 21 for details.

Power Socket Pack 2[†]

Provides two additional USB charge points in the second row.

Power Socket Pack 3^A

Provides two additional USB charge points in the second row and one additional 12V socket in the front.

Head-up Display

See page 21 for details.

Interactive Driver Display

See page 21 for details.

Audio Systems

See page 22 for details.

Connectivity Features

See page 24 for details.



Activity Key

TOWING

Fixed Rear Recovery Eye

When another vehicle is stuck in mud, snow or sand, this feature can really come into its own. Stable, robust and strong, it is ideal for any such situation – especially off-road.

Electrically Deployable Tow Bar[‡]

See page 39 for details.

Detachable Tow Bar[‡]

See page 39 for details.

Advanced Tow Assist^{‡‡}

Advanced Tow Assist allows you to control the direction of your trailer when reversing. Using the Terrain Response 2 reconfigurable rotary dial via the Touch Pro controls, the system controls the vehicle's steering to achieve the desired trailer trajectory. The Touchscreen will display both the current and desired trailer trajectory.



Advanced Tow Assist

[†]Towing weight may vary per engine. Please contact your nearest Land Rover Retailer for more information. If an Electrically Deployable or Detachable Tow Bar is selected an alternative rear tow eye cover will be present. ^{‡‡}Only available with Surround Camera or Surround Camera with Wade Sensing. HomeLink® is a registered trademark of Johnson Controls, Inc.

SELECT YOUR LAND ROVER GEAR

A range of stylish, tough and practical accessories is available, bringing you the opportunity to personalise your Range Rover Velar even further. These accessories can be purchased through your Land Rover Retailer and added at any stage during the vehicle's life – not just when it's new. Naturally, Land Rover Approved Accessories are designed, tested and manufactured to the same exacting standards as the original equipment fitted to your vehicle.

For our full range of accessories please search 'Land Rover Accessories' to view the online accessories catalogue.



TOURING ACCESSORIES

Cross Bars VPLYR0162

Elegantly designed roof rails (which are an option fit only) facilitate easy fitment of cross bars for roof carrying. Pre-set positioning points ensure cross bars are fixed in optimum position for weight distribution and dynamics. Maximum payload is 74kg**. Durable Bright finish aluminium cross bars, with T-track design which utilise the full length of the bars, providing space to mount multiple accessories. Aerodynamic profile minimises drag and wind noise. The incremental height when fitted is 93mm.

Large Sports Roof Box* VPLWR0100

Loadspace mounted rails to help increase the flexibility of loadspace stowage, also allowing the fitment of the luggage retention kit stowage system. Power-click quick mounting system with integrated torque indicator for easy and secure fixation with a single-handed grip. Opens from both sides with handles on the lid and inside the box, for convenient fitting, loading and unloading. Integrated base mat for extra secure loading. Load capacity eight skis/five-six snowboards, max length of skis 205cm. Volume 430 litres. Maximum payload 74kg**.

Centre Armrest Cooler/Warmer Box VPLVS0176

Food and drinks chiller and warmer that acts as a rear centre armrest. With a leather-covered top, it is held in place by the centre seat belt and powered from the rear auxiliary socket. Ideal for long journeys with the family.

iPhone® Connect and Charge Dock VPLRV0119

The iPhone connect and charge dock has been designed to allow visibility of the phone whilst charging, utilising the cupholder space in the centre console. When connected the iPhone media is accessible and has the ability to be controlled via the integrated infotainment/audio system. The 'cut-out' design of the holder is such that the home button is also accessible for use when parked. The iPhone USB charger can be easily disconnected if the USB connection is required for other use.

Wireless Phone Charging Cupholder VPLRV0118

The wireless phone charging cupholder has been designed to allow visibility of the phone whilst charging, utilising the cupholder space in the centre console. The holder will accommodate phones up to 73mm wide securely in place. The charger displays an LED light to indicate when charging, and turns off when complete.

Click and Go Accessory System VPLRS0388 – Base

The Click and Go range is a multi-purpose seat back system for second row passengers. The versatile Click and Go Base fixes between the headrest mountings and further attachments can be added to hold tablets, bags and shirts or jackets. Each attachment is sold separately. The base can be easily removed when not in use.



Cross Bars



Click and Go Accessory System

*Roof Rails and Cross Bars are required for all Land Rover roof mounted accessories, see page 70. Objects placed above the roof mounted satellite antenna may reduce the quality of the signal received by the vehicle and could have a detrimental effect on the navigation and satellite radio system, if fitted.

**Maximum payload equals the load capacity of the roof mounted accessory.

iPhone® is a trademark of Apple Inc., registered in the US and other countries.

DESIGN ACCESSORIES

Deployable Side Steps

Please contact your nearest Land Rover Retailer for fitment options. These smart, practical steps make it easier to get in and out of the vehicle. Neatly stowed under the sills, the side steps automatically deploy as soon as the door is opened, or when activated by the key fob. They stow automatically when the door is closed. The side steps are sensitive to obstructions and will not deploy in off-road or low range settings. Automatic mode can be overridden to allow access to the roof when the doors are closed. The deployable side steps are compatible with front mudflaps and feature a stainless steel finish with laser etched Range Rover Velar branding.

Carbon Fibre Rear Spoiler

VPLYB0354
Sleek and dynamic Carbon Fibre rear spoiler for Range Rover Velar.

Carbon Fibre Mirror Covers

VPLVB0145
Stunning high grade Carbon Fibre mirror covers, with a High Gloss finish, provide a performance-inspired premium styling update.

Carbon Fibre Side Vents

VPLYB0355
High grade Carbon Fibre side power vents with a High Gloss finish provide a performance-inspired styling upgrade.

Personalised Illuminated Front Treadplates

VPLYS0458PVJ
Personalised illuminated treadplates allow you to choose a personalised message using an approved set of fonts/typefaces which will be highlighted in white illumination when the front doors are open. Illuminated treadplates with Range Rover script and halo surround. Rear treadplates feature illuminated halo only.

Illuminated Loadspace Finisher*

LR091609
Manufactured from stainless steel with a Bright finish, the rear loadspace treadplate finisher provides protection for the loadspace trim when loading or unloading and provides a premium finish to the loadspace with subtle illumination.



Deployable Side Steps

SPORTING ACCESSORIES

Tow Bar Mounted Bike Carrier

VPLVR0066 – 2 Bike Carrier**
VPLVR0068 – 3 Bike Carrier**
Tow bar mounted bike carrier available for two or three bikes. A quick release design for ease of use and lockable for security. Maximum load capacity 51kg (on the 3 bike carrier).

Aqua Sports Carrier†

VPLGR0107
Carries one surfboard, sailboard, canoe or kayak. Includes lockable multi-purpose holder to carry a mast, oars or paddles. Tilts to facilitate easy loading/unloading. Features lockable straps and rubber supports to maintain optimum weight distribution whilst protecting the kayak and vehicle from scratches/scuffs. Maximum load capacity 45kg†.

Ski/Snowboard Holder†

LR006849
Carries four pairs of skis or two snowboards and incorporates slider rails for easy loading and is also lockable for security. Maximum payload 36kg†.

Luggage Carrier†

VPLRR0159
Flexible rack system to facilitate roof carrying. Maximum payload 61kg†.

Wheel Mounted Bike Carrier†

VPLFR0091
Lockable bike carrier designed for holding a single bike up to 20kg.

Kayak Carrier†

VPLWR0099
Carries two kayaks or canoes. Also suitable for transporting crafts such as surfboards or small boats. Includes lockable multi-purpose holder to carry paddles. Tilts to facilitate easy loading/unloading.



Tow Bar Mounted Bike Carrier

*Not compatible with Full Size Spare Wheel. **Heat shield is required for two and three tow bar mounted bike carrier – VPLWR0124. † Roof Rails and Cross Bars are required for all Land Rover roof mounted accessories, see page 70. Objects placed above the roof mounted satellite antenna may reduce the quality of the signal received by the vehicle and could have a detrimental effect on the navigation and satellite radio system, if fitted.

†Maximum payload equals the load capacity of the roof mounted accessory.

OUTDOOR ACCESSORIES

Protective Second Row Seat Covers VPLVS0312

Protects seats from wet, dirty clothes as well as general wear and tear. Simple to fit and easily wipeable. Includes headrest and armrest covers.

Full Height Luggage Partition* with Luggage Partition Divider* VPLYS0454 – Partition VPLYS0455 – Divider

Designed to prevent luggage from entering the passenger compartment. The design of the coated steel, this full height luggage partition has been optimised to second row seating featuring tilt functionality. Complies with ECE-17 regulation.

Front and Rear Mudflaps

VPLYP0318 – Front
VPLYP0319 – Rear

Mudflaps are a popular upgrade for reducing spray and ensuring paintwork is protected from debris and dirt. Designed to complement vehicle exterior styling.

Rubber Mat Set – Ebony VPLY0414

Rubber footwell mats for front and second row occupants help provide protection from general dirt. Branded and with bright accent Range Rover ingot and durable metal corner piece to the external edge.

Loadspace Rubber Mat VPLY0411

Land Rover branded waterproof rubber mat, with retaining lip, helps to protect the rear loadspace carpet from general dirt. This waterproof mat extension covers the back of the rear seats when they are folded down.

Loadspace Semi-Rigid Liner Tray VPLY0417

Semi-rigid waterproof loadspace liner tray with a raised lip on three sides to protect loadspace floor and side wall carpets from dirt or wet equipment.



Loadspace Rubber Mat

OTHER ACCESSORIES

Windscreen Sun Shield VPLYS0427

UV windscreen sun shield reflects the sun's rays and helps to keep the vehicle interior cool in hot weather.

Gearshift Paddles VPLVS0187CAY – Red VPLVS0187MMU – Aluminium

Complete the look and feel of your steering wheel with premium gearshift paddles. Gearshift paddles are machine polished, anodised and hand brushed to provide exceptional wear resistance with a premium Red or aluminium finish.

Loadspace Partition Net* VPLYS0424

Convenient loadspace partition net helps protect passengers from stowed items. The net fits to the loadspace D-loops and fixings in roof lining. Easily detachable for when carrying longer loads. Complies with ECE-17 regulation.

Luxury Carpet Mats VPLY0420

Luxurious, tailored, deep pile 2,050g/m² carpet mat set, with waterproof backing, provides a well appointed finishing touch to the interior.

Loadspace Retention Kit VPLYS0459

The loadspace retention kit consists of a pack of attachments that fix into the loadspace rails via a quick lock/quick release system to help provide a comprehensive and flexible solution for retaining luggage and other items within the loadspace. The attachment pack includes a retractable strap with inertia reel and telescopic rod. Requires loadspace rails for fitment.

Luxury Loadspace Carpet Mat VPLYS0429*

VPLYS0415 – When Full Size Spare Wheel is specified
Luxurious, tailored, deep pile 2,050g/m² loadspace carpet mat, with waterproof backing, provides a well appointed finishing touch to the interior.



Windscreen Sun Shield

TECHNICAL DETAILS

DIMENSIONS AND CAPABILITIES

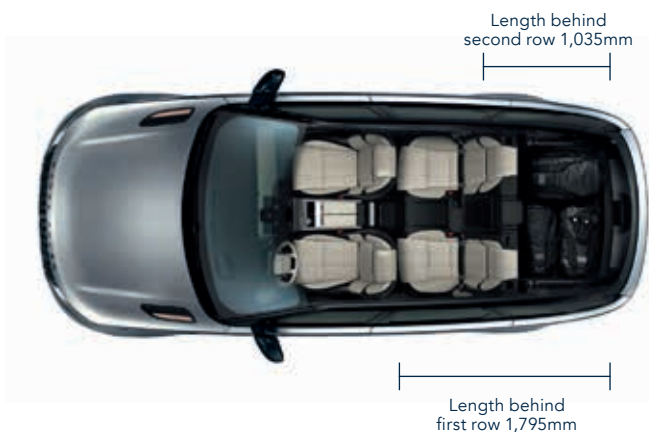

Standard Ride Height

With roof rails 1,657mm
 With roof antenna 1,685mm
 With panoramic roof open 1,705mm
 Access height air suspension setting will reduce each of the above by 40mm

Headroom

Maximum front headroom with panoramic roof 970mm
 Rear headroom 966mm

Legroom

Maximum front legroom 1,024mm
 Maximum rear legroom 945mm

Loadspace Capacity

Rear seats upright
 Height 1,045mm, Width 1,247mm
 Loadspace with Full Size Spare 531 litres
 Loadspace volume 632** litres
 Loadspace width between arches 1,050mm
 Length at floor 1,035mm

Rear seats forward
 Height 1,045mm, Width 1,247mm
 Loadspace volume 1,690** litres
 Loadspace width between arches 1,050mm
 Length at floor 1,795mm

Obstacle Clearance

Off-road height* 251mm
 Standard ride height 213mm

Turning Circle

Kerb-to-kerb 11.6m
 Wall-to-wall 12m
 Turns lock-to-lock 2.52

Wading Depth

Maximum wading depth
 650mm (Electronic Air Suspension)
 600mm (Coil Suspension)

*Electronic Air Suspension only **With Reduced Section Spare Wheel.

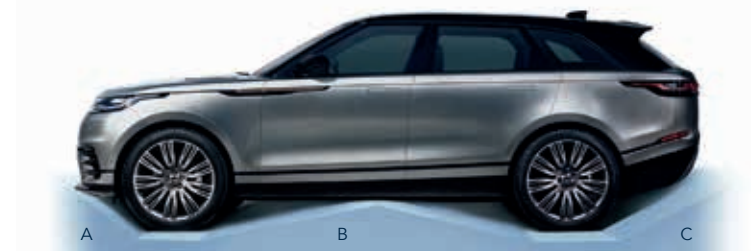
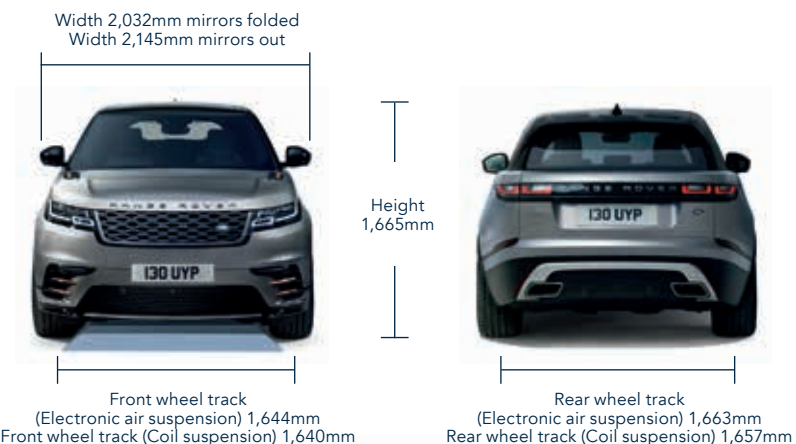

	A	B	C
Ride Height	Approach Angle	Ramp Angle	Departure Angle
Off-road from (R-Dynamic)*	28.89° (27.15°)	23.5°	29.5° (29.07°)
Standard from (R-Dynamic)	25.93° (25.06°)	21.0°	27.3° (26.8°)



TECHNICAL SPECIFICATION AND PERFORMANCE DATA

	DIESEL			PETROL	
	D180**	D240	D300	P250	P380
POWER (HP)					
ENGINE DATA					
Bore (mm)	83	83	84	83	84.5
Stroke (mm)	92.4	92.4	90	92.3	89
Compression ratio (:1)	15.5:1	15.5:1	16.1:1	10.5:1	10.5:1
BRAKES					
Front type	Single Piston Sliding Caliper Ventilated Disc			Single Piston Sliding Caliper Ventilated Disc	
Front diameter (mm)	325	325	350	325	350
Rear type	Single Piston Sliding Caliper Ventilated Disc			Single Piston Sliding Caliper Ventilated Disc	
Rear diameter (mm)	325	325	325	325	325
Park Brake		Motor on Caliper		Motor on Caliper	
WEIGHTS (KG)					
Weight from	1,829	1,841	1,959	1,804	1,884
Gross Vehicle weight	2,490	2,510	2,610	2,470	2,540
Maximum mass on each axle (front)	1,190	1,210	1,270	1,190	1,240
Maximum mass on each axle (rear)	1,420	1,430	1,470	1,420	1,440
TOWING (KG)					
Unbraked trailer	750	750	750	750	750
Maximum towing	2,400	2,500	2,500	2,400	2,500
Maximum coupling point/nose weight	175	175	175	175	175
Maximum vehicle and trailer combination/Gross Train Weight	4,890	5,010	5,110	4,870	5,040
ROOF CARRYING (KG)					
Maximum roof load (including roof rails)	79	79	79	79	79
PERFORMANCE					
Maximum speed (mph)	130*	135	150	135	155
Acceleration (secs) 0-60 mph	8.4	6.8	6.1	6.4	5.3
Fuel tank capacity – usable (litres)	60	60	66	63	63
CO ₂ Combined emissions (g/km)	From 142	From 154	From 167	From 173	From 214
Diesel Particulate Filter (DPF)	■	■	■	-	-

■ Standard – Not Available.

**If vehicle is fitted with 18" wheels the top speed will be 120 mph.

Official EU Test Figures. For comparison purposes only. Real world figures may differ. Low fuel warning at 9 litres approximately.

THE WORLD OF LAND ROVER

THERE'S A WORLD OUT THERE

Your Land Rover has been designed and engineered to help you make more of your world. It can take you to places other vehicles simply can't reach in a style that cannot be matched. To celebrate the Land Rover lifestyle, we've put together a range of experiences, publications and Land Rover branded goods. There's a world to explore. Get out there and enjoy it.

LAND ROVER EXPERIENCE

Land Rover Experience Centres have expert instructors on hand to help you make the most of driving our vehicles. You can enjoy a Taster Drive to a Full Day course at one of the centres in our expanding network around the world, visit one of our factories or go even further afield on one of our Adventure Travel holidays.

ONELIFE MAGAZINE

Free twice a year for your first three years as a Land Rover owner, this award-winning magazine features the best in photography, authoritative journalism and expert insights. Onelife takes you right into the heart of exclusive experiences and extraordinary adventures, whilst keeping you up to date with the latest innovations, design and lifestyle choices.

PARTNERSHIPS

We are delighted to partner individuals, teams and events who share our pioneering spirit. As Title and Exclusive Innovation Partner to Ben Ainslie Racing, Land Rover are an integral part of the team challenging for the biggest prize in world sailing, the 35th America's Cup.

HUMANITARIAN PARTNERSHIPS

Since 1954, Land Rover have supported the International Federation of Red Cross and Red Crescent Societies (IFRC) in reaching 150 million people needing aid in 189 National Societies.

SPECIAL VEHICLE OPERATIONS

Utilising the very latest in technologies and craftsmanship, our state-of-the-art Special Vehicle Operations facility creates the ultimate in truly personalised vehicles.

LAND ROVER COLLECTION

Our latest range of clothing and luxury leather goods is crafted with the same design excellence and attention to detail as our vehicles. We also have a collection that honours Land Rover's unique heritage and features expedition-inspired gifts and apparel.



Search 'Land Rover Experience' for full details



Search 'Land Rover Responsibility' for full details



Search 'Land Rover Featured Articles' for full details



Search 'Land Rover Partnerships' for full details



Search 'Jaguar Land Rover Special Vehicle Operations' for full details



Search 'Land Rover Collection' for full details or visit your local Land Rover Retailer

YOUR PEACE OF MIND

CUSTOMER SERVICE

When you bring your Land Rover to us, we use cutting-edge diagnostic equipment to assess all your vehicle's mechanical and electronic systems. Our qualified Technicians use tools specifically designed for our vehicles and only fit genuine Land Rover parts and accessories. A choice of service plans are available which, together with Roadside Assistance, ensures complete peace of mind.

For further details contact your local Land Rover Retailer or search 'Land Rover Ownership'.

LAND ROVER ROADSIDE ASSISTANCE

Land Rover Assistance provides assistance in motoring emergencies, from immobilisation due to breakdown or accident to minor problems such as punctures. You can rely on our roadside assistance, whatever the situation, wherever you happen to be.

For further details please consult your Warranty Benefits handbook, contact your nearest Land Rover Approved Service Centre or search 'Land Rover Roadside Assistance'.

LAND ROVER FINANCIAL SERVICES

Getting the keys to your very own Land Rover has never been so simple. And it's more affordable than you might think. New or used, for personal or business use, we have an option that puts you in complete control.

For further details contact your local Land Rover Retailer or search 'Land Rover Finance'.

FLEET & BUSINESS

Land Rover is dedicated to being the premium manufacturer of choice for fleets and businesses, by providing a highly attractive range of vehicles and exemplary customer service.

Distinctive, capable and versatile, all Land Rover vehicles deliver low Total Cost of Ownership through strong residual values, competitive service, maintenance and repair costs, and impressive fuel economy and CO₂ emissions.

We are also committed to providing a totally customer-focused aftersales service, which will ensure every Land Rover vehicle is kept on the road and in top condition, in the easiest and most cost-efficient way for businesses.

Search 'Land Rover Fleet and Business' for full details.

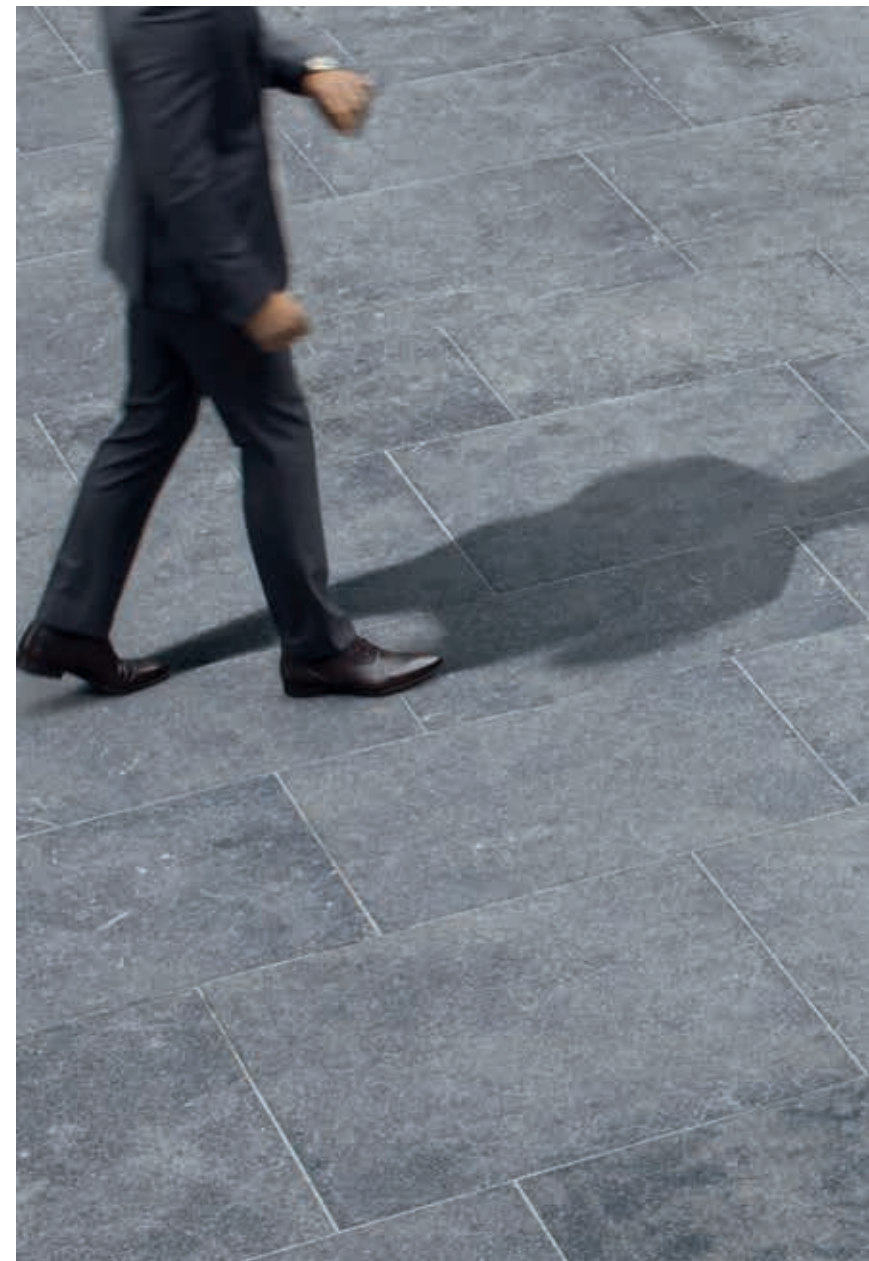



IMPORTANT NOTICE: Jaguar Land Rover Limited is constantly seeking ways to improve the specification, design and production of its vehicles and alterations take place continually. Whilst every effort is made to produce up to date literature, this brochure should not be regarded as an infallible guide to current specifications, nor does it constitute an offer for the sale of any particular vehicle. Distributors and Retailers are not agents of Jaguar Land Rover Limited by any express or implied undertaking or representation.

All Land Rover Gear – Accessories fitted by a Land Rover Retailer within one month or 1,000 miles/1,600 kilometres (which ever occurs first) of the handover of a new registered vehicle will benefit from the same warranty terms and period of cover as the vehicle warranty. Accessories purchased outside of these parameters will be subject to a 24 month unlimited mileage warranty. All Land Rover Gear – Accessories are rigorously tested to the same exacting standards as those applied to our vehicles. Performance in extreme hot and cold temperatures, corrosion resistance, impact and airbag deployment highlight some of the exhaustive product testing carried out to ensure accessories are both durable and importantly, continue to comply with current legislation. Some of the accessories featured are not available on all models. Please consult your nearest Land Rover Retailer for more information.

All our accessories are designed to be an integral part of Land Rover vehicles. While many items such as roof carriers are simple to fit, some products require specialist tools and diagnostic equipment to ensure correct integration with the vehicle structure and electrical systems. These products vary from market to market, please consult your Land Rover Retailer who will be pleased to advise you on current specifications and any query you may have.

The colours reproduced here are subject to the limitations of the printing process and may therefore vary slightly from the actual vehicle. The company reserves the right to alter or withdraw any colour finish without notice. Some of these colours may not be obtainable in your country. Please check availability of colours and current specifications with your Land Rover Retailer. Distributors and retailers are not agents of Jaguar Land Rover Limited and have absolutely no authority to bind Jaguar Land Rover Limited to any express or implied undertaking or representation.

Castrol EDGE Professional exclusively recommended by Land Rover.

Vehicle shown left, on the front and back cover is R-Dynamic P380 HSE in Silicon Silver with optional panoramic roof, Black contrast roof, privacy glass and 22" 9 split-spoke 'Style 9007' wheels with Diamond Turned finish.

Jaguar Land Rover Limited Registered Office:
Abbey Road, Whitley, Coventry CV3 4LF
United Kingdom.

Registered in England: Number 1672070

landrover.co.uk

© Jaguar Land Rover Limited 2017.
1L5601810C00GBEN01P

