

ALL-NEW JAGUAR F-PACE



THE ART OF PERFORMANCE





IMPORTANT NOTICE

Jaguar Land Rover Limited is constantly seeking ways to improve the specification, design and production of its vehicles and alterations take place continually. While every effort is made to produce up-to-date literature, this brochure should not be regarded as an infallible guide to current specifications, nor does it constitute an offer for the sale of any particular vehicle. Distributors and Retailers are not agents of Jaguar Land Rover Limited by any express or implied undertaking or representation. Comparisons are based on manufacturer's own data and testing prior to publication.

COLOURS

Print and online colours are representative only.

ENVIRONMENTAL INNOVATION AT JAGUAR

Jaguar is proud to continue the company's tradition with its approach to Environmental Innovation. From the choice of lightweight materials and lean production methods to the efficiency of its engines and designs, Jaguar is committed to operating as a more sustainable business and reducing its overall environmental impact.

Jaguar's flagship XJ model was the first in the company to achieve ISO14040, the international standard for vehicle 'life cycle assessment'. This certification measures the environmental impact of XJ from component material sourcing and manufacturing process, through driving 200,000 km. But that's not all. Every new Jaguar is designed to be 85% Recyclable/Reusable and 95% Recoverable at the end of the vehicle's life.

F-PACE, XF, XE, XJ and F-TYPE's innovative use of lightweight aluminium, which incorporates up to 50% closed-loop recycled material from the manufacturing process of the bodystructures, provides considerable performance benefits. This includes improved fuel consumption and less CO₂ emissions during the use phase of the Life Cycle due to lighter structures. Our on-going target is to ensure scrap aluminium reclaimed from our stamping process is to be segregated and recycled through a closed loop system and re-melted into the same grade quality sheet, therefore reducing CO₂ emissions during the production phase of the Life Cycle. Jaguar is committed to reducing dependency on fossil fuels, using fewer resources and creating less waste as part of our approach to sustainability excellence.

The company plan includes 25% reduction targets in operating and tailpipe CO₂ emissions, waste to landfill, logistics efficiencies (15%) and water consumption (10%), all based on per vehicle built since 2007. In addition the manufacturing assembly CO₂ emissions of each Jaguar built in the UK since 2009 is 100% offset. For each tonne of CO₂ emitted in the assembly process, Jaguar invests in projects that reduce an equivalent tonne of CO₂ elsewhere. Taking into account the company's global sales growth and increased investment in more efficient operating facilities, we are proud to have delivered and in some cases exceeded our Environmental Innovation targets as planned for 2012. And we are on track to meet our 25% reduction in joint European fleet average tailpipe CO₂ emissions by 2015.

Looking forward, we have developed our 2020 vision for sustainable business growth that focuses on continued improvements in tailpipe CO₂ emissions, operational carbon neutrality and zero waste. To date the company has offset over 6 million tonnes of CO₂, provided over 4,000 direct jobs in 60 emissions reductions projects in 17 countries and improved the lives of over 1 million people in our global cook stoves emissions reduction programme.

But it doesn't stop there. Our manufacturing facilities have been certified to ISO14001 since 1998 and we are credited to Platinum Plus level in the UK's Business in the Community Corporate Responsibility Index.

Castrol. EDGE™ Professional is exclusively recommended by Jaguar.

Meridian is the registered trademark of Meridian Audio Ltd.

AdBlue. is the registered trademark of the Verband der Automobilindustrie e. V. (VDA).

The Bluetooth. word mark and logos are owned by the Bluetooth SIG, Inc. and any use of such marks by Jaguar Land Rover Limited is under licence.

iPod, iPod touch and iPad are trademarks of Apple Inc, registered in the US and other countries.

The Navigation system must always be used in conditions that will not affect the driver's ability to drive safely or affect the safety of other road users

VEHICLE SHOWN FRONT COVER: F-PACE FIRST EDITION IN CAESIUM BLUE WITH OPTIONAL FEATURES FITTED (MARKET DEPENDENT)

VEHICLE SHOWN BACK COVER: F-PACE R-SPORT IN ITALIAN RACING RED WITH OPTIONAL FEATURES FITTED (MARKET DEPENDENT)

Jaguar Land Rover Limited
Registered Office: Abbey Road, Whitley,
Coventry, CV3 4LF, United Kingdom
Registered in England Number: 1672070
jaguar.com





BY APPOINTMENT TO
HM THE QUEEN
MANUFACTURERS OF
MOTOR VEHICLES
JAGUAR LAND ROVER LIMITED
COVENTRY



BY APPOINTMENT TO
HRH THE DUKE OF EDINBURGH
MANUFACTURERS OF
MOTOR VEHICLES
JAGUAR LAND ROVER LIMITED
COVENTRY



BY APPOINTMENT TO
HRH THE PRINCE OF WALES
MANUFACTURERS OF
MOTOR VEHICLES
JAGUAR LAND ROVER LIMITED
COVENTRY



JAGUAR

THE ART OF PERFORMANCE

Every day we push performance to its limit. Our performance. Our cars' performance.
We innovate, we engineer, we design. We master rules and then break them.
Only to push further. Past the limits of convention. This is when performance becomes art.

Jaguar. The Art of Performance.





CONTENTS

INTRODUCTION

The Concept of F-PACE	06
F-PACE - The Facts	08

DESIGN

Exterior Principles	10
Exterior Detail	12
Interior Choice	15
Interior Space	18
Practicality	20

PERFORMANCE

Engines	22
Automatic Transmission	26
Manual Transmission	27
Advanced Aerodynamics	28
Lightweight Aluminium Architecture	31
Chassis and Suspension	32
Tested to the Extreme	34

DRIVING TECHNOLOGY

Advanced Driving Dynamics	37
All Surface Progress Control	38
Advanced Drivetrain Technology	41
Torque Vectoring	42
Stability and Control	45
Head-Up Display	47
Activity Key	49

INFOTAINMENT

InControl Technologies	50
InControl Touch and InControl Connect	53
InControl Touch Pro and InControl Connect Pro	55
Audio	56

SAFETY AND EFFICIENCY

Advanced Driver Assistance	58
Efficient Technologies	60

PERSONALISATION

First Edition	63
F-PACE - Your Choice	64
Choose your Engine	66
Choose your Model	68
Choose your Options	70
Choose your Colour	78
Choose your Wheels	80
Choose your Interior	82
Choose your Jaguar Accessories	96
Technical Specifications	100
Dimensions	102

JAGUAR WORLD

Jaguar Experience	104
The World of Jaguar	106
Glossary and Legal Information	108



Scan to find out more about the All-New Jaguar F-PACE.

VEHICLE SHOWN: F-PACE FIRST EDITION IN CAESIUM BLUE WITH OPTIONAL FEATURES FITTED (MARKET DEPENDENT)

INTRODUCTION THE CONCEPT OF F-PACE

F-PACE is inspired by the acclaimed C-X17 concept vehicle. It takes the pure Jaguar DNA of legendary performance, handling and luxury. Then it adds space and practicality.

Technologically advanced to the core, F-PACE is the most practical Jaguar sports car. It combines maximum driving exhilaration with efficiency. All enhanced by technologies that keep you safe, connected and entertained. F-PACE has the capability for every road and the capacity for every day. It is the latest in a bloodline of beautiful, exciting cars. F-PACE is a Jaguar for you, a Jaguar for your family.

VEHICLE SHOWN: F-PACE FIRST EDITION IN CAESIUM BLUE WITH OPTIONAL FEATURES FITTED (MARKET DEPENDENT)

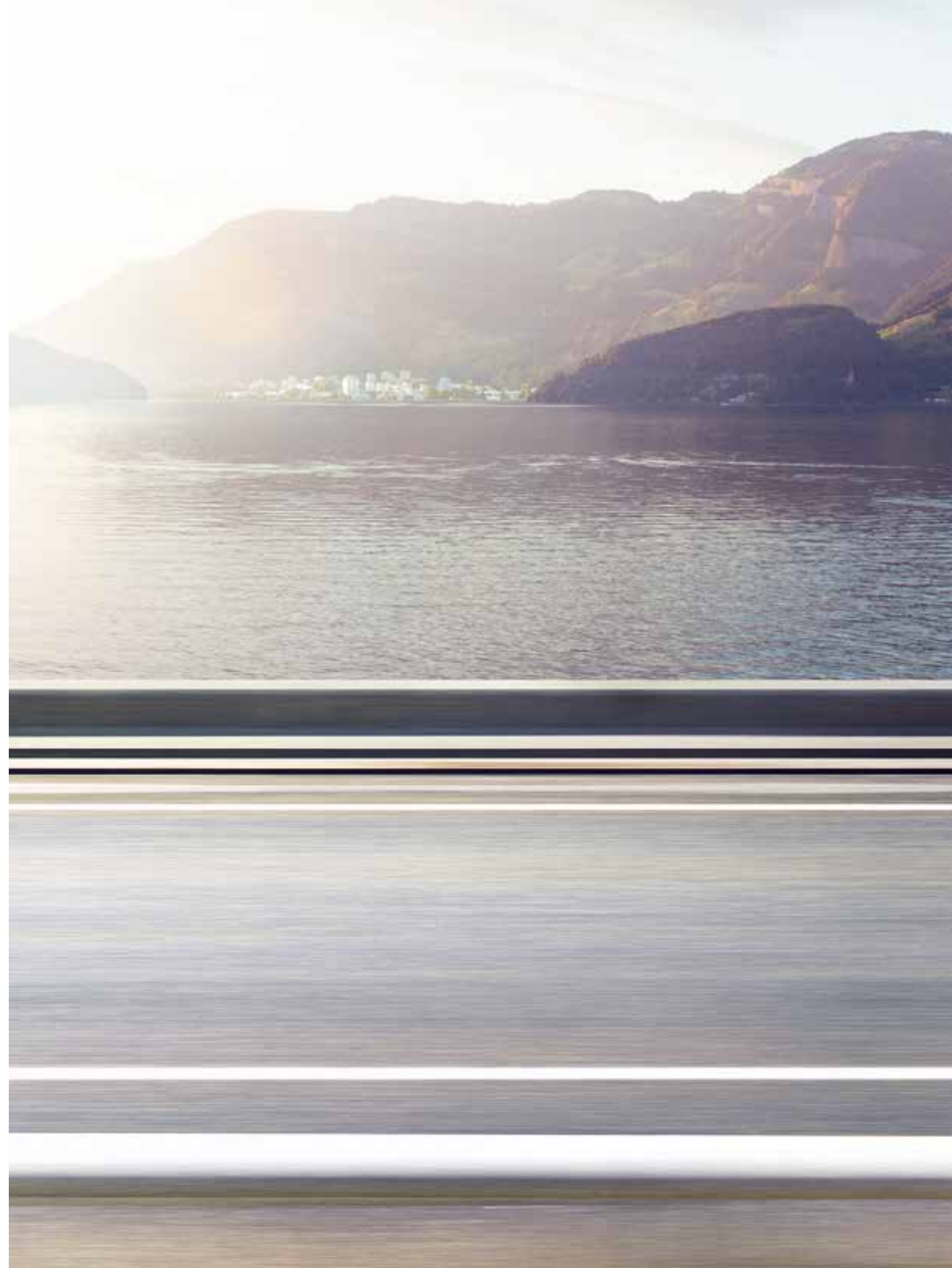



F-PACE - THE FACTS

Performance, handling and refinement. Practicality, capability and efficiency.

JAGUAR CARE†

F-PACE is offered with a new unlimited mileage, three year warranty and three years' standard servicing programme. We call this programme Jaguar Care. It makes F-PACE's overall cost of ownership one of the lowest in its class.



*Engine and transmission dependent.

**Rear Wheel Drive availability is market dependent.

†Selected European Markets only.

**Not available on manual transmission, standard on automatic transmission.

VEHICLE SHOWN: F-PACE PORTFOLIO IN GLACIER WHITE WITH OPTIONAL FEATURES FITTED (MARKET DEPENDENT)

EFFICIENCY

Every F-PACE is designed and engineered for maximum efficiency. Low friction technologies, a lightweight body structure and streamlined aerodynamics all contribute to help achieve fuel economy from 4.9 l/100km*, CO₂ emissions as low as 129g/km* and a drag coefficient from 0.34*.

PRACTICALITY

F-PACE's rear knee and leg room is amongst the best in class and it has a 40:20:40 seating configuration for greater flexibility. Boot space is class-leading at 650 litres, with carefully considered dimensions designed to maximise its usability.

CAPABILITY

F-PACE matches your practical driving needs and the demands of your lifestyle by offering the choice of either Rear Wheel Drive** or All Wheel Drive for performance across an even wider range of conditions. Capabilities can be further enhanced by All Surface Progress Control**, a low speed cruise control that helps F-PACE to cope with low traction situations.

PERFORMANCE

Discover exhilarating driving experiences across the entire F-PACE range. Our highly efficient performance engines offer a balance between economy and power. Engines include the 2.0 litre 4 cylinder 180PS Turbocharged Diesel from the Ingenium range, which can achieve 129g/km CO₂ and 4.9 l/100 km. There is also the 3.0 litre V6 380PS Supercharged Petrol that can reach a limited top speed of 250km/h with 0-100km/h acceleration in 5.5 seconds.



REFINEMENT

Our cars have an unrivalled reputation for comfort and a smooth, quiet ride. Thanks to its stiff body structure, advanced suspension and aerodynamic design, F-PACE showcases Jaguar's supreme refinement.

HANDLING

F-PACE's advanced chassis and suspension system is an evolution of the configuration used on our F-TYPE sports car. This robust system is lightweight to ensure F-PACE delivers true sports handling. Jaguar's Electronic Power Assisted Steering (EPAS) software is specially tuned for optimum feedback and control, while the All Wheel Drive system uses the F-TYPE-derived, unique Intelligent Driveline Dynamics software for an agile feel and to minimise understeer. F-PACE always drives, feels and handles like a Jaguar.

DESIGN EXTERIOR PRINCIPLES

> F-TYPE INSPIRED STYLING | PURITY OF FORM

Visually inspired by F-TYPE, the Jaguar F-PACE is a performance SUV that has the DNA of a sports car. Its powerful, agile looks make it utterly distinctive and give it a head-turning road presence. From the bonnet bulge to the pronounced rear haunches, F-PACE reinvents the energy, strength and purity of form of F-TYPE.

VEHICLE SHOWN: F-PACE R-SPORT IN ITALIAN RACING RED WITH OPTIONAL FEATURES FITTED (MARKET DEPENDENT)







EXTERIOR DETAIL

ADAPTIVE LED HEADLIGHTS*

Even at night, F-PACE is instantly recognisable thanks to its Adaptive LED headlights* featuring Jaguar's signature 'J' Blade Daytime Running Lights. Adding to F-PACE's commanding on-road presence, Adaptive LED headlights* produce an intensity of light that is close to daylight, helping your eyes to distinguish objects more easily and reducing fatigue. At the rear, full LED tail lights echo F-TYPE's distinctive design.

*Fitment dependent on derivative and market. Xenon or Halogen headlights are also available depending on model chosen.
VEHICLE SHOWN: F-PACE FIRST EDITION IN CAESIUM BLUE WITH OPTIONAL FEATURES FITTED (MARKET DEPENDENT)







INTERIOR CHOICE



SPORTS COMMAND DRIVING POSITION

EXTENSIVE PERSONAL CHOICE

F-PACE's interior blends sportiness and elegance to create the latest in contemporary design. Our extensive range of premium materials, handpicked leathers and sophisticated finishes, gives F-PACE one of the most comprehensive interior choices in its class*. This is your perfect opportunity to create a space that reflects your individual style.

Take personalisation to the next level with optional Configurable interior mood lighting**. The system highlights the finest interior design details with soft pools of light in a choice of ten different colours. F-PACE can create an ambience to match your mood. F-PACE's modern interior design means essential controls are intuitive to use and always close at hand. A high centre console and the Sports Command driving position help the driver feel connected and secure. Slender roof pillars and a large windscreen mean all-round visibility is excellent.

*Compared to segment competitors.

**Fitment is market and derivative dependent.

**VEHICLE SHOWN: F-PACE PORTFOLIO WITH SIENA TAN PERFORATED WINDSOR LEATHER SEATS.
OPTIONAL FEATURES FITTED (MARKET DEPENDENT)**







INTERIOR SPACE

 PANORAMIC ROOF | OPTIMISED REAR SPACE

VEHICLE SHOWN PREVIOUS PAGE: F-PACE R-SPORT FEATURING JET/RED PERFORATED TAURUS LEATHER SPORTS SEATS WITH RED CONTRAST STITCH. OPTIONAL FEATURES FITTED (MARKET DEPENDENT)

VEHICLE SHOWN THIS PAGE: F-PACE PORTFOLIO FEATURING SIENA TAN PERFORATED WINDSOR LEATHER SEATS WITH SIENA TAN TONAL STITCH. OPTIONAL FEATURES FITTED (MARKET DEPENDENT)



Choose one of our optional panoramic glass roofs* to flood your F-PACE's interior with light and enhance the airy, spacious feeling. The Fixed Panoramic roof* brings the outside in by giving everyone superb views of the sky, while the Sliding Panoramic roof* allows fresh air into the cabin whenever you want it. For greater privacy and to reduce excessive heating under intense sunlight, every panoramic roof* is fitted with an electric blind as standard.

In the back, there's space for three adults to sit comfortably side by side. Rear leg and knee room are 945mm and 65mm respectively. Throughout the car you'll find neatly placed, versatile storage. There are useful pockets for smartphones and other small items either side of the centre console, as well as below the touchscreen.

*Fitment of panoramic glass roof is market and model dependent.

40:20:40
650 Litres*†

PRACTICALITY



CLASS-LEADING BOOT SPACE

VERSATILE SEATING

F-PACE has a boot capacity of a class-leading 650 litres*†, substantially greater than its nearest competitor. The space is made even more versatile by the rear seats' 40:20:40 configuration. They can be folded completely, or folded individually, in a variety of combinations, to accommodate both passengers and awkward items such as skis. With the rear seats folded flat, F-PACE's total loadspace is an impressive 1,740* litres.

The parcel shelf, so often a difficult object to store, can be stowed under the loadspace floor*. The loadspace floor is reversible and can be switched, in an instant, from luxury carpet to an easy-clean, rubberised surface-perfect for damp or muddy equipment. Transferring items into and out of F-PACE is made easier by the low loading height and wide boot opening.

Powered Tailgate and Gesture Tailgate are available as options on F-PACE. With Gesture Tailgate you don't even have to touch the car when your hands are full – simply present your foot under one of F-PACE's rear flanks and the tailgate opens or closes.‡



*When Tyre Repair System is fitted.

†Below the parcel shelf.

‡Requires Jaguar Smart Key System with Keyless Entry and Push Button Start.

VEHICLE SHOWN: F-PACE R-SPORT IN ITALIAN RACING RED, FEATURING JET/RED PERFORATED TAURUS LEATHER SPORTS SEATS WITH RED CONTRAST STITCH. OPTIONAL FEATURES FITTED (MARKET DEPENDENT)

40:20:40
1,214 Litres*



40:20:40
1,380 Litres*



40:20:40
1,740 Litres*



PERFORMANCE ENGINES



RESPONSIVE ENGINES

EFFICIENCY AND PERFORMANCE

F-PACE offers a choice of refined, efficient diesel or petrol engines – all delivering a dynamic driving experience and responsive Jaguar performance. F-PACE's engines are equipped with Stop/Start technology* and smart regenerative charging – harvesting kinetic energy from braking to charge the battery – for maximum economy, especially during urban driving. For information on fuel consumption, CO₂ emissions and performance figures for F-PACE engines, please refer to pages 66-67.



INGENIUM DIESEL FROM

129g/km CO₂

F-PACE is offered with the 2.0 litre 4 cylinder 180PS Turbocharged Diesel from our Ingenium range. Ingenium is Jaguar Land Rover's new breed of engine designed for effortless performance, refinement and efficiency. With advanced technology and all-aluminium construction Ingenium delivers impressive fuel consumption and CO₂ emissions. Typically, 20kg lighter than equivalent previous generation engines, Ingenium is intrinsically more efficient.

And intelligent too – computer controlled, adaptive engine cooling only engages as required. The latest generation variable geometry turbocharger maximises peak power for low speed torque and responsiveness that is uniform, progressive and avoids lag. Internal friction – the enemy of performance and efficiency – is 17 percent lower in the Ingenium range than previous generation engines. Ingenium diesel engines are available with Rear Wheel Drive Manual, All Wheel Drive Manual and All Wheel Drive Automatic transmissions.

*Market dependent



DIESEL ENGINE

0-100km/h in 6.2 seconds

The powerful 3.0 litre V6 Turbocharged Diesel engine offers exceptional refinement and efficiency, increasing power to 300PS and torque to an impressive 700Nm for improved performance and excellent drivability. Its high pressure common rail fuel system delivers efficient combustion and fewer emissions. The engine uses innovative twin parallel sequential turbocharging – a concept pioneered by Jaguar Land Rover – for smooth, more immediate delivery of power at all engine speeds, as well as two-stage water cooling to conserve energy. It is capable of 0-100km/h in 6.2 seconds with CO₂ emissions of just 159g/km CO₂ on the European combined cycle. The V6 Diesel engine is available with All Wheel Drive Automatic transmission only.

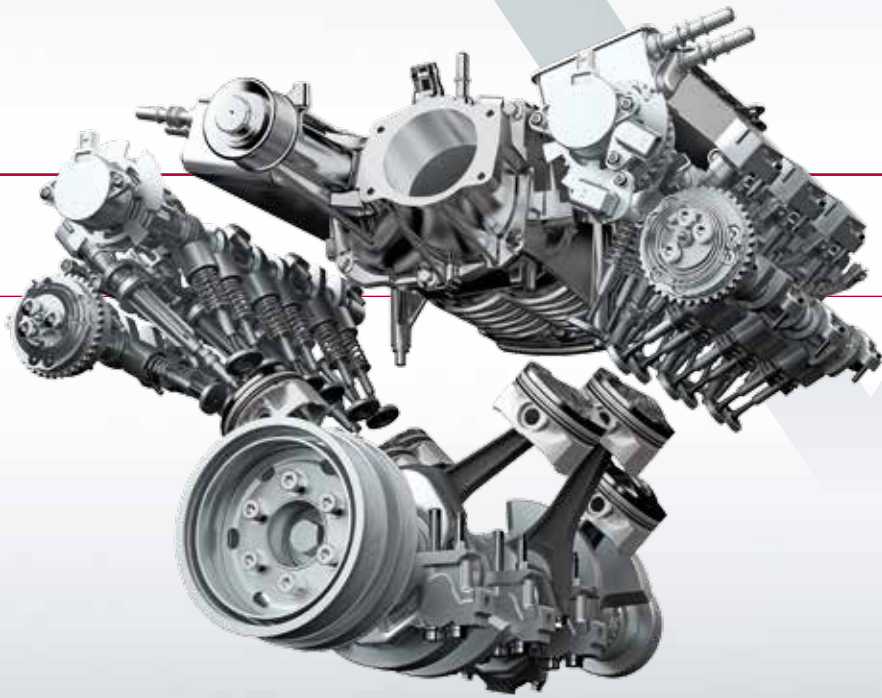

PETROL ENGINES

0-100km/h in 5.5 seconds

F-PACE's petrol engines offer power and responsiveness throughout the rev range, while improving efficiency. Shared with F-TYPE, the 3.0 litre V6 Supercharged Petrol engine is available in both 340PS and 380PS versions. At 380PS the engine is capable of 0-100km/h in 5.5 seconds. This all-aluminium engine delivers instant access to high levels of torque at all engine speeds, and a unique soundtrack.

The 3.0 litre V6 Supercharged Petrol engine has been adapted for the specific requirements of F-PACE. A Roots-type twin vortex supercharger is mounted in the 'V' between the two rows of cylinders for compact dimensions. Supercharging provides linear delivery of power and maximises responsiveness. This results in performance matching much larger engines, while optimising economy and reducing emissions. The engine also features dual independent variable cam timing to vary inlet and exhaust valve operation, working alongside lightweight pistons with ultra-low friction piston rings, for increased performance and efficiency. For added refinement there is a twin, contra-rotating balancer shaft system. The V6 Petrol engine is available with All Wheel Drive Automatic transmission only.

VEHICLE SHOWN: F-PACE R-SPORT IN ITALIAN RACING RED WITH OPTIONAL FEATURES FITTED (MARKET DEPENDENT)



AUTOMATIC TRANSMISSION

EIGHT-SPEED AUTOMATIC TRANSMISSION

F-PACE's automatic transmission is highly responsive, smooth and efficient. Developed specifically for the demands of a performance SUV, it delivers rapid shifting for effortless acceleration and overtaking. This intelligent, adaptive system subtly changes the way the throttle delivers power, as well as gearshift patterns, to suit your particular driving circumstances. The unique JaguarDrive Control system offers even quicker shifts and sportier kickdown in Dynamic Mode, and earlier up-shifts in Eco Mode to improve efficiency while the Rain Ice Snow Mode enhances the vehicle stability in low grip conditions by allowing for more gentle progress. The driver can also opt to manually control gearshifts via the steering wheel paddles at the touch of a finger.



MANUAL TRANSMISSION

SIX-SPEED MANUAL TRANSMISSION*

Choose the Six-Speed manual transmission* for even greater driver involvement. This lightweight, highly advanced gearbox contributes to F-PACE's outstanding efficiency. Its aluminium alloy casing, hollow shafts and pocketed gears save every gram of weight possible. We use an advanced direct lubrication system to reduce friction and drag for greater efficiency and further weight saving. Originally designed for the performance requirements of sports cars, F-PACE's outstanding Six-Speed manual transmission delivers slick, short changes and superb levels of comfort.

*Only available on 2.0 litre 4 cylinder 180PS Turbocharged Diesel engine (market dependent).





ADVANCED AERODYNAMICS



LOW DRAG

INCREASED STABILITY

F-PACE's aerodynamic performance is a key function of its body design and supports an impressive drag coefficient from Cd 0.34*. The result is that F-PACE really is as sleek as it looks. Highly advanced aerodynamics reduce fuel consumption, CO₂ emissions and wind noise while adding to high speed stability and driver confidence. F-PACE's innovative, lightweight underbody design is as important as the body you can see. The smooth underbody surfaces manage airflow to optimise cooling of the engine and brakes as well as helping to minimise drag, reduce turbulence and increase efficiency. As air reaches the back of F-PACE, the car's sharply angled rear corners and integrated spoiler limit pressure differences forming in the wake of the car for improved fuel economy.

*Engine and model dependent.

VEHICLE SHOWN: F-PACE PORTFOLIO IN GLACIER WHITE WITH OPTIONAL FEATURES FITTED (MARKET DEPENDENT)





LIGHTWEIGHT ALUMINIUM ARCHITECTURE

 **STRONG** | **RIGID** | **80% ALUMINIUM***

Jaguar has been at the forefront of aluminium car construction for more than a decade. Our latest innovation is the Lightweight Aluminium Architecture that provides the foundations for F-PACE. We use aluminium where possible because it creates a stiff, strong and, most importantly, lighter architecture. The architecture's incredible strength offers excellent protection to all occupants, while its reduced weight enhances handling and braking. Aluminium has also been used to form the body sides, bonnet and front wings of F-PACE.

The use of aluminium enables F-PACE to be amongst the lightest cars in its class** - boosting efficiency from the outset. The reduced weight of F-PACE's structure is distributed with a near perfect 50:50** balance for a sporting performance and an impeccable ride.

*Aluminium content based on volume for body structure excluding doors, bonnet and tailgate.

**Model and engine dependent.

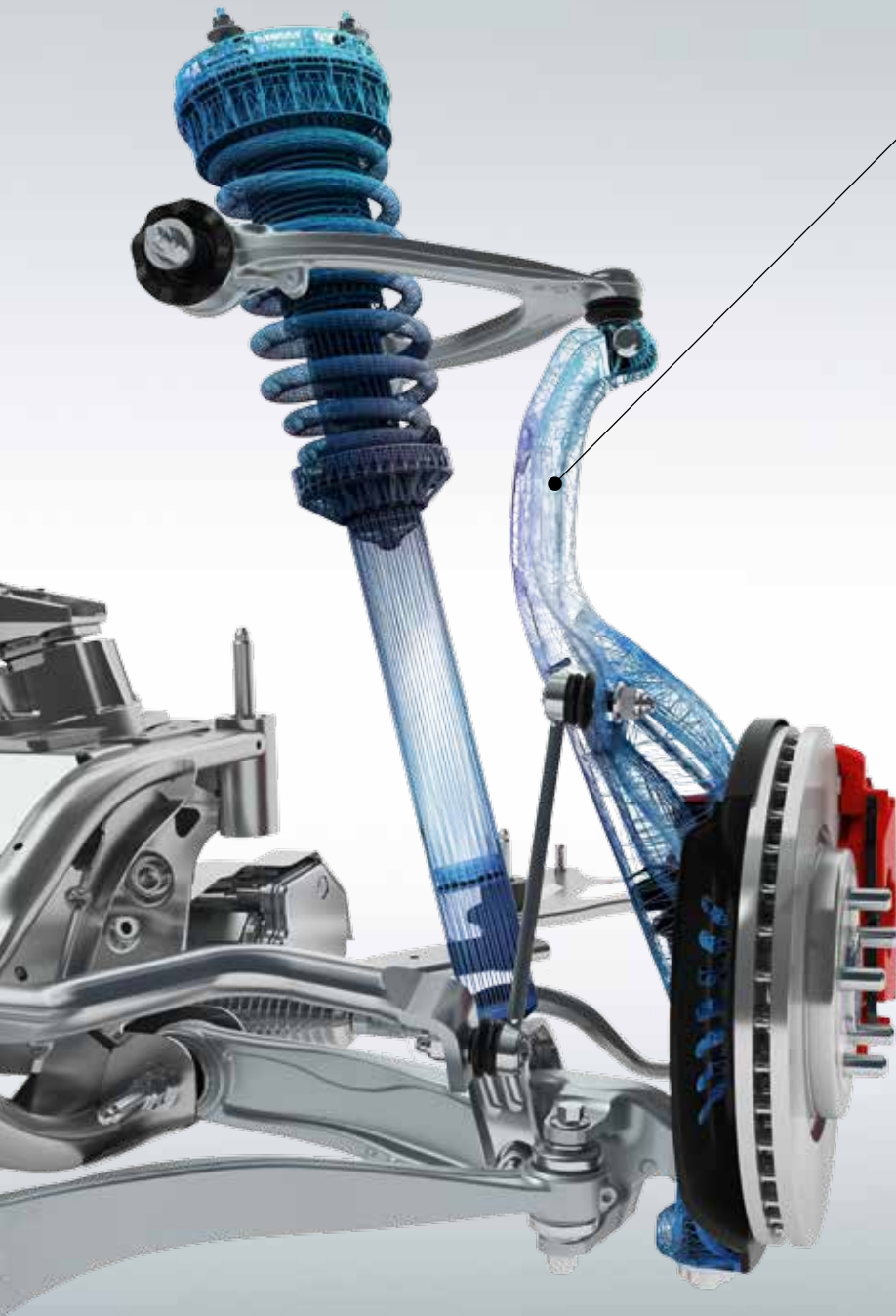

ALUMINIUM FRONT KNUCKLE

Designed to optimise stiffness and strength, the lightweight aluminium front knuckle helps improve F-PACE's agility, responsiveness and refinement for sports car inspired control.

CHASSIS AND SUSPENSION



**SUPERB RIDE
AND HANDLING**

**UNIQUE SUSPENSION
TECHNOLOGY**

Underpinning F-PACE is an evolution of F-TYPE's chassis and suspension system - it offers a unique balance between agility and ride comfort. This ensures that F-PACE feels like a true Jaguar and is a pleasure to drive or be driven in. In combination with this suspension, F-PACE's stiff body structure and the use of lightweight acoustic damping materials create supreme refinement.

INTEGRAL LINK REAR SUSPENSION

Integral Link suspension allows F-PACE to realise a perfect combination of a refined, luxurious ride and sharp, responsive handling. The system, unique for this class of car, separates and independently manages the lateral, longitudinal and vertical forces acting on the suspension for enhanced control and comfort. Many components are forged or hollow-cast in aluminium – the optimum production techniques for strong, lightweight suspension.

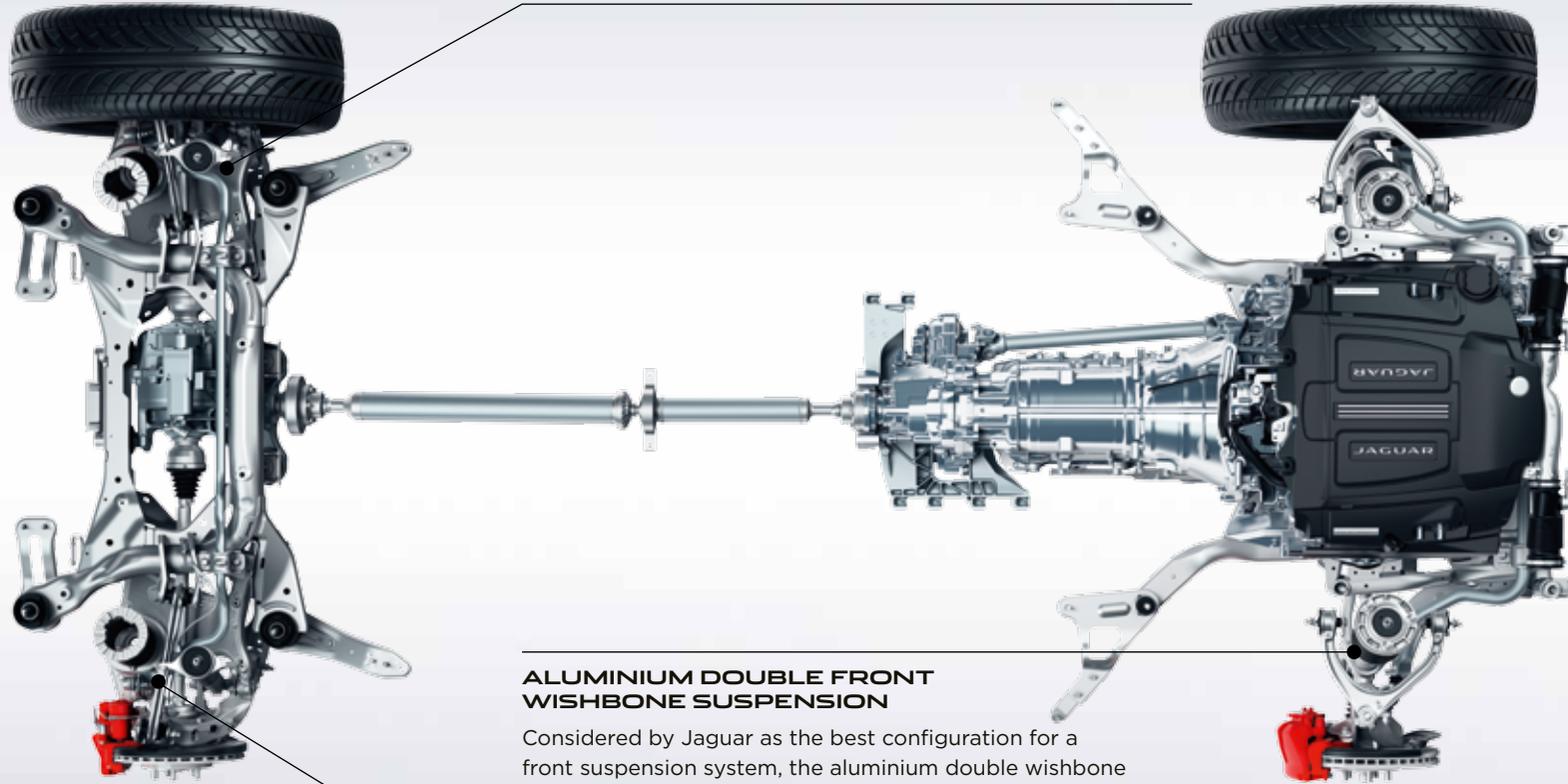

ALUMINIUM DOUBLE FRONT WISHBONE SUSPENSION

Considered by Jaguar as the best configuration for a front suspension system, the aluminium double wishbone design is modelled closely on F-TYPE's for precise handling and control.

ADAPTIVE DYNAMICS*

The optional Adaptive Dynamics system delivers both precise dynamics and a supple, luxurious ride by monitoring wheel position and body movements. The system constantly monitors conditions and adjusts the dampers to provide the optimum balance between comfort and refinement at all times.

*Standard on F-PACE S and F-PACE First Edition, optional on other models.



SUSPENSION

We create unique algorithms to represent the strains and stress equivalent to 250,000 km or ten years of driving on our state-of-the-art rig.



COLD CLIMATE

-40°C in our cold climate chamber ensures that when F-PACE is hard at work outside in freezing conditions, everything on the inside is working for your total comfort.



HOT TESTING

In the hot room temperatures can soar up to 55°C. We can recreate wind speeds of up to 240km/h and roads speeds as high as 250km/h. There's nowhere you can take F-PACE that it hasn't been already.

TESTED TO THE EXTREME

> -40°C TO 55°C | FROM THE ARCTIC TO DUBAI

From the Arctic Circle and the mountains of China to the sands of Dubai and coast to coast in North America, F-PACE has seen almost everything the world's roads can throw at it. Then we brought F-PACE home to our UK testing facilities and things got really tough...



MONSOON TESTING

The Monsoon chamber drenches F-PACE at every stage of the development process. We test for water management and dispersal along its body and over its windows. And we make sure that F-PACE stays dry inside as well as corrosion-free.



SEMI-ANECHOIC CHAMBER

Our 'neutral sound' room is where we make sure F-PACE sounds like a true Jaguar with its distinctive exhaust note.



FINAL INSPECTION

At the end of the production line every car is scrutinised by one of the most complex instruments in the world – the human eye. F-PACE undergoes an exhaustive visual inspection by expert quality inspectors.

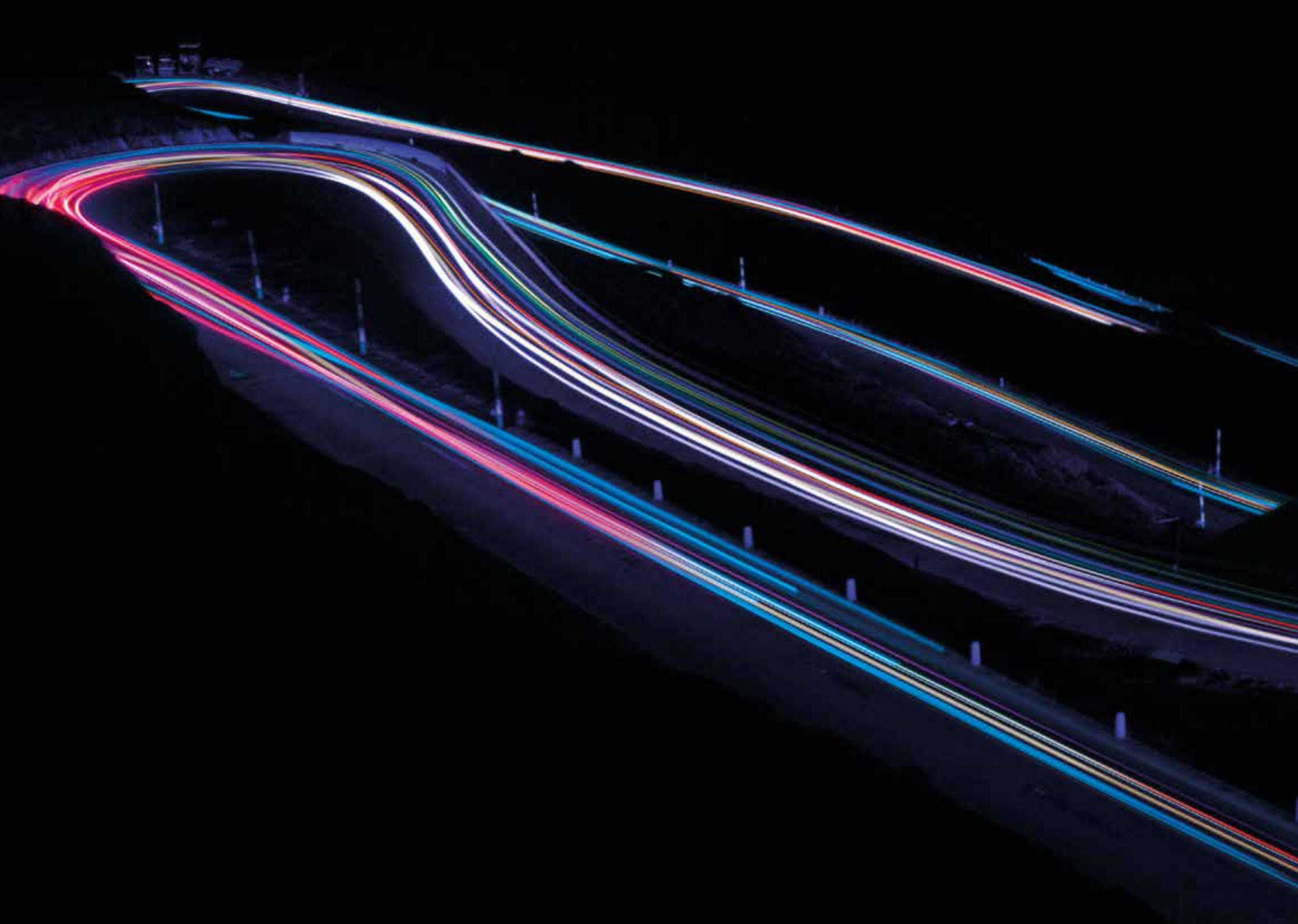

ADVANCED DRIVING DYNAMICS



MAXIMISING AGILITY

CONTINUOUSLY ADAPTING

Dynamic Mode revises the car's software to further enhance F-PACE's sporting character. It sharpens the throttle response, increases steering weighting and performs gearshifts more quickly* and at higher engine speeds. It also brings visual drama to the driver as the instrument cluster takes on a red glow. Dynamic Mode enhances your connection with F-PACE's inherent Jaguar performance.

ELECTRIC POWER ASSISTED STEERING

Electric Power Assisted Steering (EPAS) offers outstanding feedback, control and it is active on demand - saving power for where you really need it, as well as saving fuel. EPAS' sophisticated computer management varies steering assistance as appropriate - increasing assistance for low speed manoeuvring and improving feel at higher speeds. It also enables advanced safety features such as Lane Keep Assist and Park Assist.

ADAPTIVE DYNAMICS**

Whether you're accelerating on the motorway, cornering on country roads or navigating around town, optional Adaptive Dynamics modifies F-PACE's response to match the conditions and your driving style. It analyses acceleration, cornering, throttle and brake pedal activity as well as kick-down activation. Steering and body movement are analysed up to 500 times a second. Electronically controlled dampers then constantly adjust to optimise the suspension settings and maintain F-PACE's dynamism and comfort.

CONFIGURABLE DYNAMICS**

Bringing technology from F-TYPE, the optional Configurable Dynamics* system allows you to set up F-PACE's dynamics for throttle mapping, gearbox shift points and steering to suit your performance driving needs. When optional Adaptive Dynamics is fitted, you can make your setting even more personal by configuring the damper settings.

*Automatic transmission only.

**Standard on F-PACE S and F-PACE First Edition, optional on other models.

DRIVING TECHNOLOGY

ALL SURFACE PROGRESS CONTROL

ADDED DRIVER CONFIDENCE | LOW SPEED CRUISE CONTROL

Unique in this class of car, Jaguar's All Surface Progress Control (ASPC) technology is a low speed cruise control that helps F-PACE to cope with low traction situations. ASPC allows the driver to concentrate on steering the vehicle. Once activated, you use the cruise control buttons to set a 'target' speed of between 3.6km/h and 30km/h. The system then works to achieve and maintain that speed while exerting optimum traction control.

ASPC is standard on all engines fitted with automatic transmissions and gives F-PACE drivers added confidence over slippery, loose or icy surfaces, undulating terrain and even while descending a difficult incline. It helps make F-PACE easy to drive in challenging conditions. ASPC also has a pull-away function allowing F-PACE to progress from rest on low grip surfaces and ascending gradients, as well as a hill descent function that controls vehicle speed on steeper inclines.

Feature not available with Manual Transmission.



GRAVEL



WET GRASS



SNOW/ICE



WET ROAD

DRY ROAD CONDITIONS

In normal driving conditions, virtually all torque is distributed to the rear wheels providing signature Jaguar rear wheel drive performance.

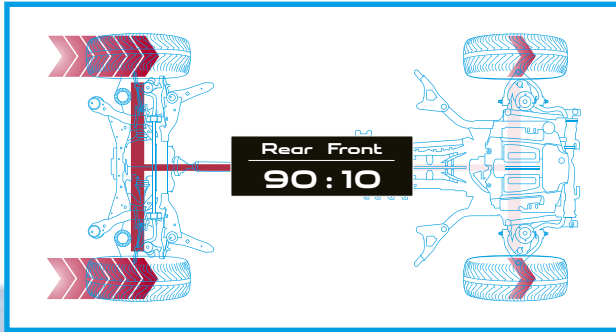

LOW TRACTION CONDITIONS

On slippery surfaces, such as grass and mud, torque can be balanced 50:50 between the front and rear wheels to maximise traction.

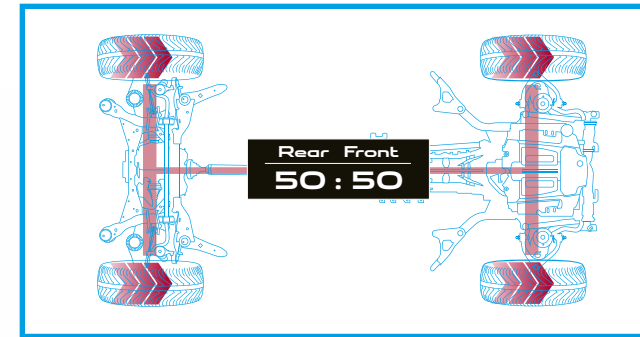

VARIABLE ROAD CONDITIONS

Where road conditions are changeable, over 90 percent of torque can be intelligently distributed from the rear wheels to the front to optimise traction in all conditions.

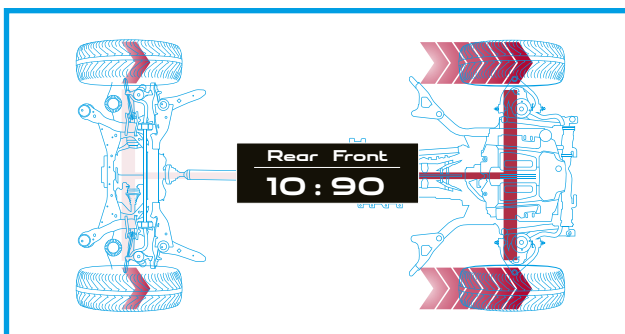

ADVANCED DRIVETRAIN TECHNOLOGY



ALL WHEEL DRIVE

ADAPTIVE SURFACE RESPONSE

F-PACE's All Wheel Drive (AWD) system delivers confident handling on all surfaces. The drivetrain technology offers a reduction in weight and an increase in efficiency compared to previous generation systems. At its heart is an extremely fast-reacting, compact transfer case with integrated Intelligent Driveline Dynamics (IDD) software. Exclusively developed by Jaguar, the unique IDD software features sophisticated algorithms to react intelligently to road conditions for traction on demand. Whenever greater traction is needed, IDD ensures that precisely the right amount of torque is transferred to the front wheels - a process that takes no more than 165 milliseconds. Offering a smoother, safer drive, the system also consumes less fuel and has lower emissions than permanent AWD. Predictive, as well as reactive, the system helps prevent you from losing traction instead of working to regain it.

On All Wheel Drive vehicles fitted with Adaptive Dynamics*, optional Adaptive Surface Response (ASR) recognises differences between surfaces to exploit the maximum available grip. Drawing on Jaguar Land Rover's unrivalled expertise with All Wheel Drive systems, ASR constantly monitors the car's environment and adjusts the appropriate engine and brake settings. Once selected, ASR works at all speeds to support you in adverse weather and across challenging surfaces.

*Adaptive Dynamics is standard on F-PACE S and F-PACE First Edition.

TORQUE VECTORING



MAXIMISED CORNERING CAPABILITY

F-PACE's Torque Vectoring by braking maximises capability through even the tightest corners. Torque Vectoring technology provides controlled independent braking on the individual inside front and rear wheels to add to the turning forces acting on the car. In most conditions more braking pressure is applied to the rear inside wheel as this supports the most increased cornering capability, while the front inside wheel is braked for greater effectiveness and refinement. The result is reduced understeer for sharper turning and more consistent road holding. Torque Vectoring delivers increased sports car-like agility and added driver confidence.

ADDITIONAL ROTATIONAL FORCE
APPLIED AROUND VEHICLE'S AXIS

TORQUE VECTORING APPLIES
BRAKE PRESSURE TO SLOW
THE INSIDE FRONT AND INSIDE
REAR WHEELS INDEPENDENTLY

POWER IS SUSTAINED TO
MAINTAIN CONSTANT SPEED
OF OUTER DRIVEN WHEELS

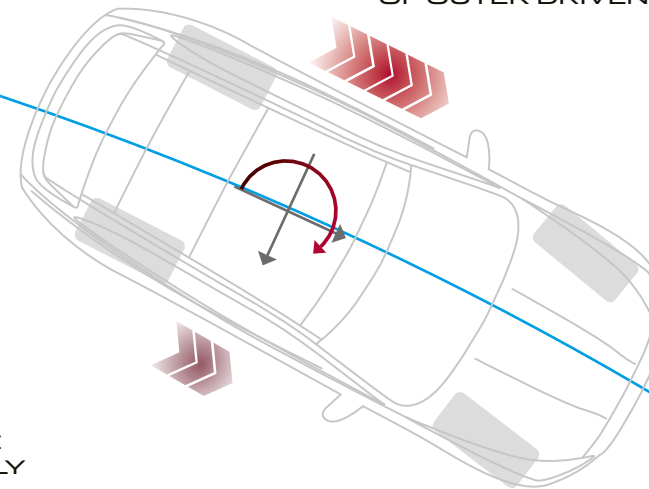

VEHICLE SHOWN: F-PACE R-SPORT IN ITALIAN RACING RED WITH OPTIONAL FEATURES FITTED (MARKET DEPENDENT)







UNDERSTEER

OVERSTEER

BRAKING APPLIED TO APPROPRIATE WHEELS TO COUNTERACT UNDERSTEER/ OVERSTEER

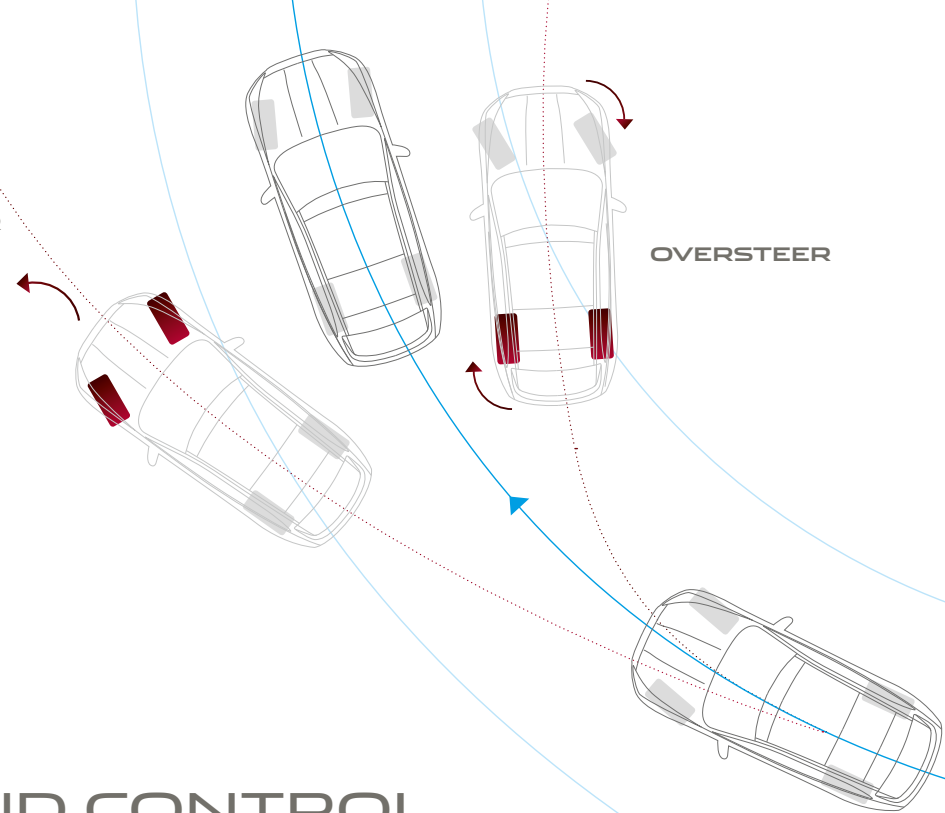

STABILITY AND CONTROL



DYNAMIC STABILITY CONTROL

ENGINE DRAG TORQUE CONTROL

TRAILER STABILITY ASSIST

Jaguar's stability systems keep F-PACE safely balanced whether you're driving enthusiastically or simply want the assurance of a car that will remain stable in challenging conditions.

Dynamic Stability Control (DSC) monitors F-PACE's dynamic behaviour, intervening to maximise vehicle stability and optimising available grip. DSC reduces engine torque and applies braking to the appropriate wheels to correct the car's direction of travel by counteracting understeer or oversteer. F-PACE's DSC system has enhanced understeer control to reduce speed and regain control more effectively.

Engine Drag torque Control (EDC) mitigates the chance of wheel lock-up caused by strong engine braking in slippery conditions. It acts by briefly increasing torque to the wheels as appropriate.

Trailer Stability Assist (TSA) gives you greater stability when towing. Should TSA detect a dangerous trailer sway situation is developing, it can help you regain control by gradually reducing F-PACE's speed through lowering engine power and applying the brakes individually on each side of the vehicle to control the sway.

VEHICLE SHOWN: F-PACE R-SPORT IN ITALIAN RACING RED WITH OPTIONAL FEATURES FITTED (MARKET DEPENDENT)



HEAD-UP DISPLAY

> HEAD-UP DISPLAY WITH LASER TECHNOLOGY

The optional Head-Up Display (HUD)* with laser technology projects key information onto the windscreen. Remaining clear even in direct sunlight, the crisp, bright image can display vehicle speed, navigation, cruise control notifications, and Traffic Sign Recognition data, where available. This technology helps you minimise time spent looking down at the instrument cluster and can help you maintain continuous awareness of the car's speed.

ADAPTIVE CRUISE CONTROL WITH QUEUE ASSIST**

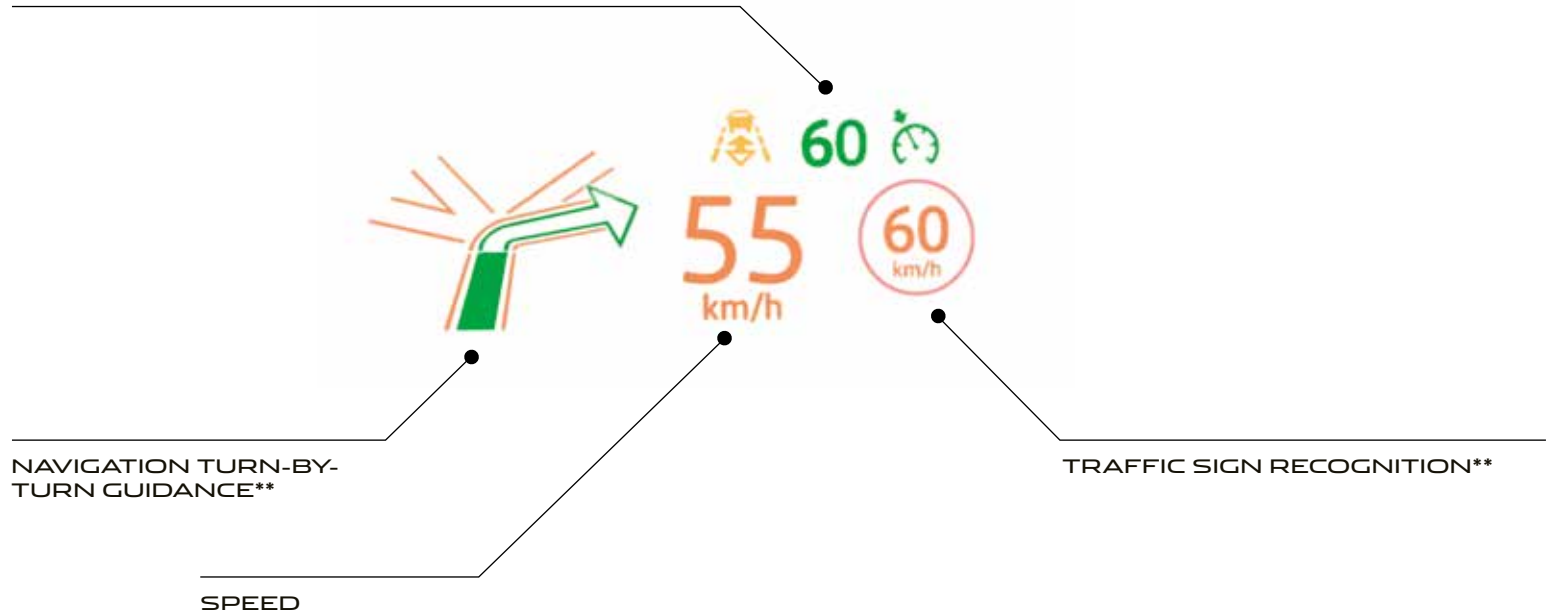

*Requires Infrared Reflective windscreen to be fitted.
**Optional features with fitment market dependent.





ACTIVITY KEY



ROBUST

WATERPROOF

SECURE

Activity Key* makes living life to the full even easier. For extra convenience, you can wear the Activity Key if you prefer not to carry a key fob. The wristband is robust and fully waterproof. It allows you to enjoy a range of activities – from skydiving to swimming – and keep your car key with you. You can use the Activity Key to lock and unlock your car. When exiting the car, you can leave the conventional key fob in the car and present the Activity Key to the tailgate to lock it. The conventional key fob is then automatically deactivated for security.

*Optional feature. Also available as Jaguar retailer fit Accessory.

VEHICLE SHOWN: F-PACE PORTFOLIO IN GLACIER WHITE WITH OPTIONAL FEATURES FITTED (MARKET DEPENDENT)

INFOTAINMENT INCONTROL TECHNOLOGIES

 **INCONTROL TOUCH** | **INCONTROL TOUCH PRO**

InControl is our suite of advanced technologies that links both you and your F-PACE to the wider world. Choose from two InControl infotainment systems: InControl Touch, available as standard, or upgrade to InControl Touch Pro*. These can be further enhanced by adding their respective connectivity packages, InControl Connect* and InControl Connect Pro*.

*As we systematically introduce InControl, specific features, options and its availability remain market dependent.

**Only available with InControl Apps or InControl Connect Pro (see optional connectivity packages for InControl Touch Pro).

Third Party programmes or applications may require an end user license from the supplier.



INCONTROL TOUCH



STANDARD ON EVERY F-PACE

8 inch Touchscreen
 5 inch Instrument Panel Display with analogue dials
 Jaguar Sound System (80W)
 FM Radio, iPod, 1 x USB, Bluetooth® and 1 x AUX connection



InControl Protect consists of
 SOS Emergency Call, Jaguar Optimised Assistance
 and Remote Essentials smartphone app



OPTIONAL

InControl Connect consists of InControl Apps,
 Remote Premium smartphone app and Wi-Fi Hotspot



InControl Secure provides Stolen Vehicle Monitoring and
 notifications via your smartphone and the secure call centre

ADDITIONAL OPTIONS

Meridian Sound System (380W)
 InControl Touch Secure Digital (SD) Navigation
 DAB Radio

For information on InControl Touch see pages 52-53.



INCONTROL TOUCH PRO



AVAILABLE AS AN UPGRADE

10.2 inch Touchscreen with multi-touch gestures
 and customisable homescreen
 12.3 inch Instrument Panel Display with virtual dials
 and full screen 3D Map View
 InControl Touch Pro Solid State Drive (SSD) Enhanced Navigation
 Meridian Digital Sound System (380W)
 FM Radio, iPod, Bluetooth® and 2 x USB connections
 10GB of usable memory
 CD/DVD Drive



InControl Protect consists of
 SOS Emergency Call, Jaguar Optimised Assistance
 and Remote Essentials smartphone app



OPTIONAL

InControl Connect Pro consists of InControl Apps,
 Remote Premium smartphone app, Wi-Fi Hotspot and
 Pro Services



InControl Secure provides Stolen Vehicle Monitoring and
 notifications via your smartphone and the secure call centre

ADDITIONAL OPTIONS

Meridian Digital Surround Sound System (825W)
 Digital TV, HDMI**, MHL**
 DAB Radio

For information on InControl Touch Pro see pages 54-55.



8 INCH TOUCHSCREEN SHOWN AT ACTUAL SIZE

Audio	Standard: Jaguar Sound System (80W) Optional: Meridian Sound System (380W)
Navigation Guidance	InControl Touch SD Navigation*
Display	5 inch Instrument Panel Display with analogue dials
Multimedia	FM and DAB Radio*. iPod, 1 x USB, Bluetooth® and 1 x AUX connection
Standard InControl Package	InControl Protect consists of SOS Emergency Call, Jaguar Optimised Assistance and Remote Essentials smartphone app
Optional Connectivity Package	InControl Connect consists of InControl Apps, Remote Premium smartphone app and Wi-Fi Hotspot

*Optional features.

INCONTROL TOUCH



ADVANCED INFOTAINMENT AS STANDARD

The InControl Touch multimedia system is F-PACE's hub for connectivity, control and entertainment. The key features are:

8 inch Touchscreen at the heart of the centre console. Clear and responsive graphical interface for quick control.

Easy to use Touchscreen responds directly to touch and swipe gestures.

Navigation guidance* makes planning journeys and following routes easy, thanks to turn-by-turn voice guidance and junction view. 'Dead-reckoning' functionality can accurately position the vehicle even when GPS signals can no longer be received – perfect for city centres or driving through tunnels.

Bluetooth phone connectivity allows you to link and control your smartphone via InControl Touch either for phone calls or music playback: simple, easy and wire-free.

Access a world of music thanks to FM, DAB*, Satellite and HD radio* (subject to regional fitment), as well as iPod, USB and AUX connections.

Integrated text-to-voice* technology reduces distraction by reading out incoming text messages. You can easily respond with short, prepared messages.

Precise climate control is available via the Touchscreen. Adjust temperature levels, direction and intensity of airflow and operate heated or cooled seats (if fitted).

INCONTROL CONNECT



OPTIONAL CONNECTIVITY PACKAGE

InControl Connect* is a bundle of technologies and applications that takes your F-PACE's connectivity to the next level.

InControl Apps features a range of bespoke Jaguar approved apps that can be connected to the car from your smartphone. It ensures the safe and convenient use of these apps that have been optimised specifically to enhance aspects of your in-car experience.

Wi-Fi Hotspot gives you the option to create a 3G hotspot using the car's antenna when you fit a SIM card. This strengthens your link to the outside world, for a more stable connection than an individual device could maintain. Connect up to eight devices to read emails, browse the web and download content.

Remote Premium is a multi-function app that allows you to monitor as well as interact with your F-PACE from your smartphone. Remote start the engine* to pre-condition the climate, lock and unlock the car, locate your F-PACE on a map or by using the beep and flash function, and track your journeys – all via the app.



Explore InControl at jaguar.com/incontrol

*Optional features.

As we systematically introduce InControl, specific features, options and its availability remain market dependent.

Please consult your local Jaguar retailer for further details. Wi-Fi Hotspot requires the fitment of a Standard SIM with a suitable data contract.



10.2 INCH TOUCHSCREEN SHOWN AT ACTUAL SIZE

Audio	Standard: Meridian Digital Sound System (380W) Optional: Meridian Digital Surround Sound System (825W)
Navigation Guidance	InControl Touch Pro SSD Enhanced Navigation
Display	12.3 inch Instrument Panel Display with virtual dials and full screen 3D Map View
Multimedia	FM and DAB Radio*, iPod, Bluetooth®, HDMI†, MHL† and 2 x USB connections. Digital TV*, 10GB of usable memory and CD/DVD Drive
Standard InControl Package	InControl Protect consists of SOS Emergency Call, Jaguar Optimised Assistance and Remote Essentials
Optional Connectivity Packages	InControl Connect Pro consists of InControl Apps, Remote Premium, Wi-Fi Hotspot and Pro Services (including Route Planner Companion App, share your destination and ETA, Commute Mode, Arrival Mode, real time traffic information and fuel and parking services)



12.3 inch Instrument Panel Display with virtual dials

*Optional features.

†Only available with InControl Apps or InControl Connect Pro (see optional connectivity packages for InControl Touch Pro).
Please consult your local Jaguar retailer for further details. Certain features require the fitment of a Micro SIM with a suitable data contract.

INCONTROL TOUCH PRO

UPGRADE TO NEXT GENERATION INFOTAINMENT

InControl Touch Pro's next-generation hardware and software advances F-PACE's connectivity and entertainment to the very highest level. InControl Touch Pro's features replace or enhance those found in InControl Touch. The key aspects of InControl Touch Pro are:

Larger, highly-responsive, 10.2 inch Touchscreen at the heart of the centre console with customisable home screen and lightning fast response times. Its interactive side panel makes multi-tasking easy.

Pinpoint touch control allows you to manipulate and interact with information swiftly and seamlessly. The Touchscreen responds in the same manner as a smartphone or tablet computer, providing multi-touch gestures such as pinch to zoom and swipe.

12.3 inch Instrument Panel Display with Virtual Dials and full screen 3D Map View makes driving even more of a pleasure. It is housed in the instrument display directly in front of the driver. Select full screen 3D Map View or choose one of four graphical themes to suit your personal preference.

Enhanced Navigation with faster response times. One of the many innovative features of InControl Touch Pro's Navigation is that it allows you to set a destination and the system alerts you if you have insufficient fuel for the journey. It then displays filling stations on the part of the route where you may be low on fuel. The system automatically displays parking options.

Personal media storage of 10GB of usable memory for your music and movies. 'Plug and play' using the two USB ports allowing for fast transfer speeds.



Explore InControl at jaguar.com/incontrol

*Optional features.

As we systematically introduce InControl, specific features, options and its availability remain market dependent.

Please consult your local Jaguar retailer for further details. Certain InControl Connect Pro features require the fitment of a Micro SIM with a suitable data contract.

INCONTROL CONNECT PRO

OPTIONAL ENHANCED CONNECTIVITY PACKAGE

InControl Connect Pro's services, technologies and applications give you the very best in connectivity and convenience. It offers all the benefits of InControl Connect (see pg. 53) plus many more features, including:

Route Planner Companion App offers true door-to-door navigation. Pre-plan your destination and route via your Apple or Android smartphone. The app will guide you to your car, where you will find your selected route available on the car's Touchscreen. When you've completed your road journey, the app can guide you by foot or public transport (where supported) to your destination.

Share your estimated time of arrival so your selected contact(s) will know exactly when you will arrive, as calculated by the navigation guidance system. If you're running late, the system can then send automatic updates via text or email, without any further action from you.

Commute Mode allows the system to learn your commutes and automatically advises you of the expected journey time based on live and historical traffic movements. The system learns the routes you take for a given destination and then advises which of those is the quickest.

Arrival Mode displays interactive 360 degree street level imagery of your destination for seamless finishes to journeys. It automatically displays again upon your arrival. You then simply tap the Touchscreen to select a nearby car park, which appears as an updated destination.

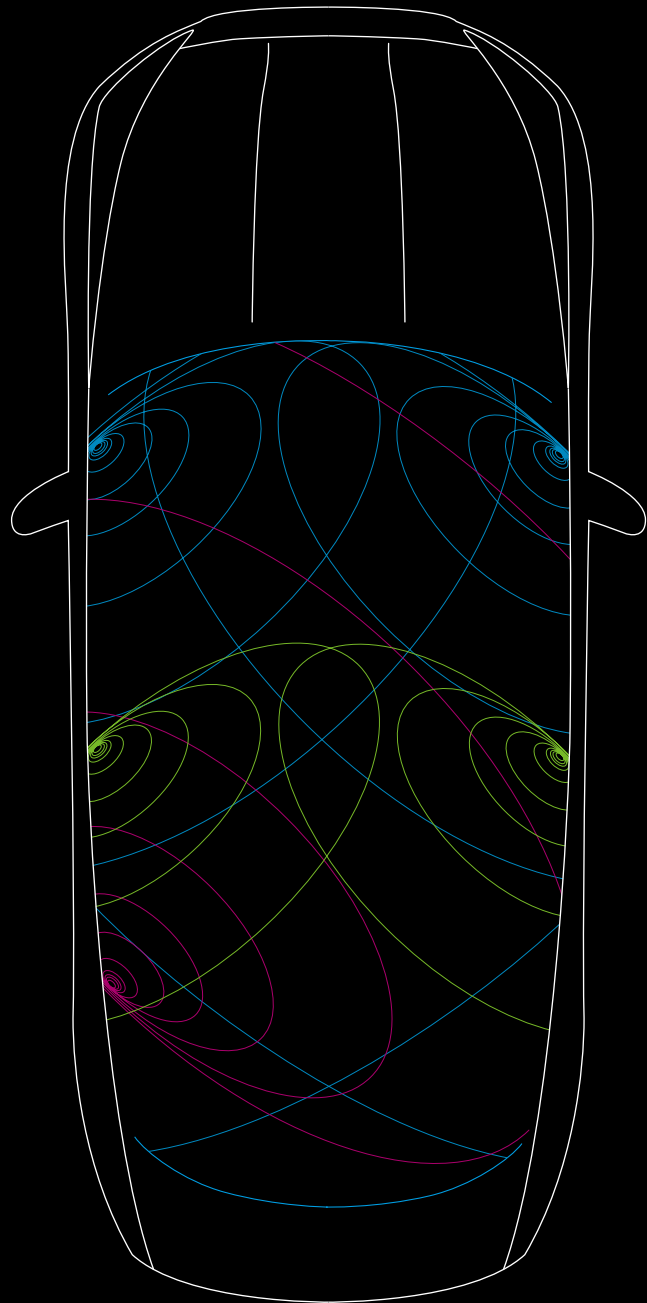

AUDIO



JAGUAR
SOUND SYSTEM

MERIDIAN
SOUND SYSTEMS

F-PACE's superb sound systems bring your music to life. The Jaguar Sound System provides acoustic range through 6 speakers. Offering an enhanced listening experience are the optional Meridian Sound Systems. Designed in conjunction with the British audio experts Meridian, these systems use innovative audio technology and precise speaker placement to give perfectly optimised sound quality.

Choose from a range of audio systems, including the new digital 380W Sound System with 11 speakers or the digital 825W Surround Sound System with 17 speakers. All systems ensure that, wherever you or your passengers sit in your F-PACE, everyone will enjoy a rich, enveloping audio experience.



-  Fresh air subwoofer
-  Front door waves tweeter midrange bass
-  Rear door waves tweeter midrange

Diagram representative of Meridian 380W Sound System.



MERIDIAN

SOUND SYSTEMS AVAILABLE IN CONJUNCTION WITH **INCONTROL TOUCH**

Standard

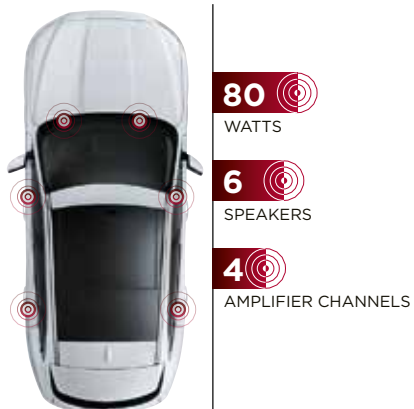

JAGUAR SOUND SYSTEM

Dynamic Volume Control*
80 watts
6 speakers
4 amplifier channels

Optional

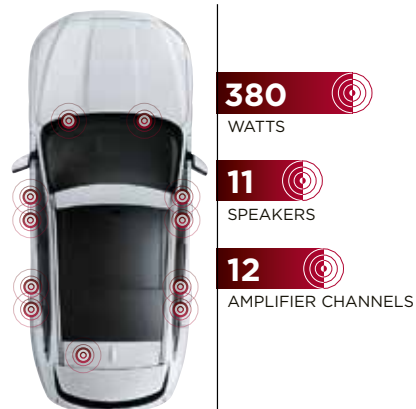

MERIDIAN SOUND SYSTEM

Dynamic Volume Control*
380 watts
11 speakers including sub woofer
12 amplifier channels

SOUND SYSTEMS AVAILABLE IN CONJUNCTION WITH **INCONTROL TOUCH PRO**

Standard

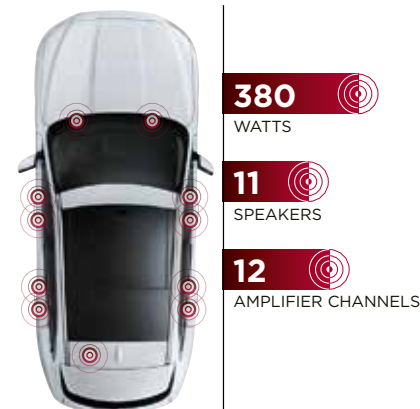

MERIDIAN DIGITAL SOUND SYSTEM

Dynamic Volume Control**
380 watts
11 speakers including sub woofer
12 amplifier channels
Advanced DSP with fully digital amplification
Audyssey MultEQ Audio Equalisation

Optional

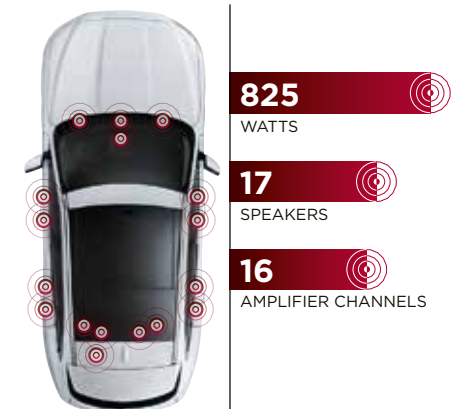

MERIDIAN DIGITAL SURROUND SOUND SYSTEM

Dynamic Volume Control**
825 watts
17 speakers including sub woofer
16 amplifier channels
Advanced DSP with fully digital amplification
Audyssey MultEQ Audio Equalisation
Meridian Trifield Technology

*Automatically adjusts as vehicle speed changes.

**Automatically adjusts as vehicle speed changes and/or ambient noise levels change.

VEHICLE SHOWN: F-PACE PORTFOLIO IN GLACIER WHITE WITH OPTIONAL FEATURES FITTED (MARKET DEPENDENT)

SAFETY AND EFFICIENCY ADVANCED DRIVER ASSISTANCE



1 AUTONOMOUS EMERGENCY BRAKING*

Should a potential collision be detected, F-PACE gives an audible forward collision warning. Visual warnings follow. If the driver takes no action, the system applies the brakes to help reduce the severity of the possible impact. This system also includes pedestrian sensing.

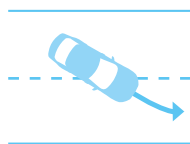

2 LANE DEPARTURE WARNING*

Lane Departure Warning (LDW) notifies the driver with a visual alert and a gentle vibration of the steering wheel should the car detect an unintentional drift from its lane, helping to keep everyone on board safe.

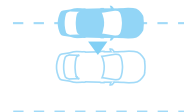

3 LANE KEEP ASSIST AND DRIVER CONDITION MONITOR**

Building on Lane Departure Warning, Lane Keep Assist (LKA) senses unintentional lane drift and helps steer F-PACE back into its lane. Driver Condition Monitor (DCM) detects lapses in concentration due to tiredness by monitoring driver inputs and suggests taking a break via an audible alert and a visual notification in the instrument cluster.

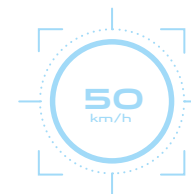

4 TRAFFIC SIGN RECOGNITION WITH INTELLIGENT SPEED LIMITER**

Traffic Sign Recognition technology detects speed limits, including variable limits, and no overtaking signs via the forward-facing camera, then displays them to the driver. The Intelligent Speed Limiter uses detected traffic sign information to help keep F-PACE within the appropriate speed limit. Where no traffic sign is detected, the Intelligent Speed Limiter can also use the map data from the optional navigation system.



5 BLIND SPOT MONITOR AND REVERSE TRAFFIC DETECTION**

Blind Spot Monitor alerts you to vehicles or obstacles beside F-PACE, as well as ones approaching from a distance behind, via an icon displayed in the appropriate exterior mirror. Reverse Traffic Detection extends the Blind Spot Monitor function and alerts you via the Touchscreen of moving vehicles during reversing - for example, when leaving a parking bay with restricted vision.



6 PARK ASSIST**

Park Assist makes parking in tight spaces easier than ever. F-PACE can accurately steer itself during both parallel and bay parking manoeuvres - the driver only has to control the brakes and accelerator. An exit-assist function can help guide F-PACE while leaving a parallel space.

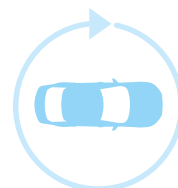

7 SURROUND CAMERA SYSTEM**

Surround Camera System gives you 360° exterior vision on the Touchscreen. This helps with various manoeuvres from parking by a kerb to getting in and out of tight spaces and junctions.



8 ADAPTIVE CRUISE CONTROL WITH QUEUE ASSIST**

Adaptive Cruise Control[†] uses radar technology to automatically adjust your speed to maintain a safe distance from the vehicle ahead. If that vehicle slows, your F-PACE reduces its speed to maintain a safe distance. F-PACE resumes its pre-set speed as soon as the road in front is clear. Should the car in front stop completely, the Queue Assist function brings F-PACE to a smooth halt. Once the traffic moves off, touch the accelerator and F-PACE will follow the car in front again.

*Standard feature.

**Optional features, availability and fitment is market dependent.

†Only available on automatic transmission.

Please refer to page 75 for fitment requirements.

VEHICLE SHOWN: F-PACE PORTFOLIO IN GLACIER WHITE WITH OPTIONAL FEATURES FITTED (MARKET DEPENDENT)

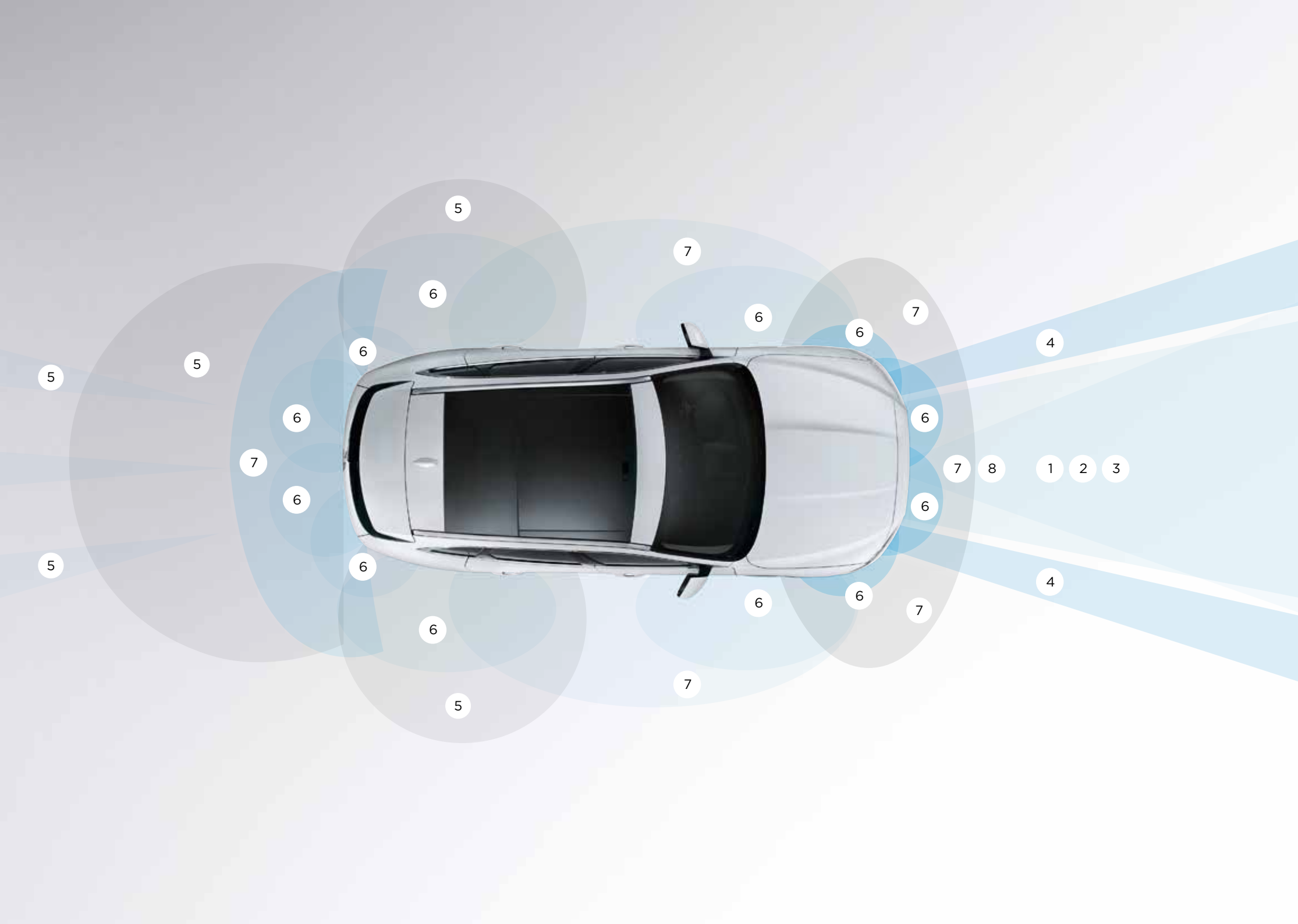

EFFICIENT TECHNOLOGIES

 **LOW FRICTION** | **CLEAN TECHNOLOGIES**

Everyone wants to do more with less. That is why F-PACE uses a range of technologies to reduce fuel consumption and CO₂ emissions, all while staying true to Jaguar's dynamic nature.



SUSTAINABLE CONSTRUCTION

The aluminium alloy used for much of F-PACE's construction is from a high level of recycled aluminium. Using significantly less energy than primary aluminium to produce, it minimises F-PACE's environmental impact.

STOP/START

All F-PACE's engines are available with Stop/Start*. It shuts down the engine when you come to a complete halt and restarts the engine immediately when required. Helping to save fuel, especially during urban driving.

*Market dependent.
**Engine and transmission dependent.



LIGHTWEIGHT MATERIALS

At every stage of the development process, engineers maximised weight saving across all the car's elements. This produces an optimum balance between best performance and weight saving for greater efficiency.



ADVANCED AERODYNAMICS

F-PACE's aerodynamics are developed and optimised with the aid of computational fluid dynamics analysis. By increasing stability and minimising drag, F-PACE's fuel consumption can reach 4.9 l/100km** with CO₂ emissions as low as 129 g/km**.

AdBlue®

ADBLUE®*

F-PACE's diesel models are fitted with AdBlue® to help clean exhaust gases. AdBlue® is a non-toxic, non-flammable, biodegradable additive that cleanses the gases in the car's exhaust system to remove harmful nitrogen oxide emissions.



LOW FRICTION TECHNOLOGIES

The Ingenium engine range uses smart coating technologies on pistons, needle roller bearings and other mechanical parts. This helps to reduce friction, especially at low engine temperatures, so the car performs at its efficient best.



FIRST EDITION



EXCLUSIVE F-PACE FIRST EDITION

UNIQUE SPECIFICATION

Get closer to F-PACE's inspiration - the acclaimed C-X17 concept vehicle - with the unique, sporty First Edition. This limited edition F-PACE, of just 2,000 vehicles, gives you exclusive design details and high specification features. Experience the excitement of driving an F-PACE with the individuality of limited edition style. The First Edition is available with 3.0 litre V6 300PS Turbocharged Diesel and 3.0 litre V6 380PS Supercharged Petrol engines. It is available in two unique colours, Caesium Blue and Halcyon Gold. You can also choose Rhodium Silver or Ultimate Black.

UNIQUE FEATURES:

22" Double Helix Alloy Wheels with Grey finish and contrast inserts • Two unique colours, Caesium Blue and Halcyon Gold • Unique interior with Houndstooth embossed Windsor Leather Sports seats and Gloss Black trim finisher with Houndstooth pattern • Unique carpet mats

STANDARD FEATURES*

S Body kit including S front and rear bumpers, Body-coloured S door claddings with Satin Chrome finishers

- Satin Chrome radiator grille surround with Gloss Black mesh insert
- Gloss Black side window surrounds and side power vents
- Illuminated metal treadplates with Jaguar script and metal loadspace scuff plate
- LED headlights with LED 'J' Blade Daytime Running Lights
- Sliding Panoramic roof
- Sport seats
- 10-way Electric front seats
- Bright Sport pedals
- Adaptive Dynamics
- Red brake calipers
- Rain sensing windscreen wipers with Automatic Headlamps
- Electrically reclining rear seats
- Satin Chrome gearshift paddles
- Configurable interior mood lighting
- InControl Touch Pro
- Meridian Digital Sound System

*Availability and fitment is market dependent.

VEHICLES SHOWN: F-PACE FIRST EDITION IN CAESIUM BLUE, RHODIUM SILVER, HALCYON GOLD AND ULTIMATE BLACK. OPTIONAL FEATURES FITTED (MARKET DEPENDENT)



PERSONALISATION F-PACE - YOUR CHOICE

 Configure your vehicle at jaguar.com



CHOOSE YOUR ENGINE

Page 66

Select one of F-PACE's powerful, efficient petrol or diesel engines to suit your driving style.

CHOOSE YOUR MODEL & OPTIONS

Page 68

Compare the wealth of standard features and options on F-PACE models.

CHOOSE YOUR COLOUR

Page 78

Express your individuality with one of F-PACE's stunning exterior colours.

CHOOSE YOUR WHEELS

Page 80

Add the personal finishing touch to your new F-PACE, and complement its stunning style, with a set of beautifully designed alloy wheels.

CHOOSE YOUR INTERIOR

Page 82

There's a wide selection of premium materials, leathers, veneers and finishes for every personal taste.

CHOOSE YOUR JAGUAR ACCESSORIES

Page 96

Really make it yours by adding style, practicality and versatility with official F-PACE Accessories from your local Jaguar Retailer.

1 CHOOSE YOUR ENGINE

 Configure your vehicle at jaguar.com

> DIESEL ENGINES

2.0 LITRE 4 CYLINDER

TURBOCHARGED

MAXIMUM POWER 180PS

MAXIMUM TORQUE 430 Nm

ACCELERATION 0-100 km/h 8.9 seconds

TOP SPEED Manual 209 km/h*

COMBINED 4.9 l/100km

CO₂ Manual 129 g/km

PURE, PRESTIGE, PORTFOLIO, R-SPORT

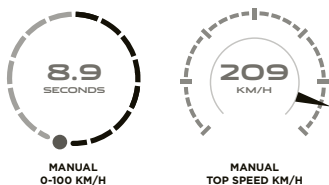

2.0 LITRE 4 CYLINDER AWD

TURBOCHARGED

MAXIMUM POWER 180PS

MAXIMUM TORQUE 430 Nm

ACCELERATION

Manual/Automatic 0-100 km/h 8.7 seconds

TOP SPEED Manual 208 km/h Automatic 208 km/h

COMBINED Manual 5.2 l/100km Automatic 5.3 l/100km

CO₂ Manual 134 g/km Automatic 139 g/km

PURE, PRESTIGE, PORTFOLIO, R-SPORT

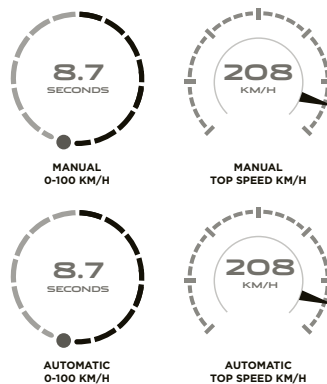

3.0 LITRE V6 AWD

TURBOCHARGED

MAXIMUM POWER 300PS

MAXIMUM TORQUE 700 Nm

ACCELERATION 0-100 km/h 6.2 seconds

TOP SPEED Automatic 241 km/h

COMBINED 6.0 l/100km

CO₂ 159 g/km

PURE, PRESTIGE, PORTFOLIO, R-SPORT, S

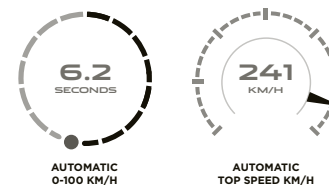

*On Pure models top speed is restricted to 195km/h when fitted with 18" alloy wheels and 235/65 R18 tyres. Please consult your local Jaguar retailer for further details.

Please refer to Technical Specification pages for full fuel consumption figures.

The figures provided are as a result of official manufacturer's tests in accordance with EU legislation.

A vehicle's actual fuel consumption may differ from that achieved in such tests and these figures are for comparative purposes only.

> PETROL ENGINES

3.0 LITRE V6 AWD SUPERCHARGED

MAXIMUM POWER 340PS
MAXIMUM TORQUE 450 Nm
ACCELERATION 0-100 km/h 5.8 seconds
TOP SPEED Automatic 250 km/h*
COMBINED 8.9 l/100km
CO ₂ 209 g/km
PURE, PRESTIGE, PORTFOLIO, R-SPORT

3.0 LITRE V6 AWD SUPERCHARGED

MAXIMUM POWER 380PS
MAXIMUM TORQUE 450 Nm
ACCELERATION 0-100 km/h 5.5 seconds
TOP SPEED Automatic 250 km/h*
COMBINED 8.9 l/100km
CO ₂ 209 g/km
S



AUTOMATIC
0-100 KM/H



AUTOMATIC
TOP SPEED KM/H



AUTOMATIC
0-100 KM/H



AUTOMATIC
TOP SPEED KM/H

*Limited top speed

2 CHOOSE YOUR MODEL

 Configure your vehicle at jaguar.com

LUXURY



PURE

KEY FEATURES

- 18" alloy wheels
- Halogen headlights with Daytime Running Lights
- Premium Cloth seats
- 8-way Manual front seats
- Gloss Black trim finisher



PRESTIGE

KEY FEATURES (IN ADDITION TO PURE)

- Bi-function Xenon headlights with LED 'J' Blade
- Daytime Running Lights
- Headlight powerwash
- Taurus Leather seats
- Chrome side window surround
- Front fog lights
- Carpet mats
- Interior mood lighting



PORTFOLIO

KEY FEATURES (IN ADDITION TO PRESTIGE)

- 18" alloy wheels (style change)
- Perforated Windsor Leather Luxury seats
- 10-way Electric front seats
- Configurable interior mood lighting
- Gloss Figured Ebony veneer

Standard features may vary depending on market, engine variant and transmission. Please refer to Specification and Price guide or website for your local market.

> SPORT



R-SPORT

KEY FEATURES (IN ADDITION TO PURE)

- 19" alloy wheels
- R-Sport Body kit including R-Sport front and rear bumpers, Body-coloured door claddings with Satin Black finishers
- Satin Chrome radiator grille surround and side power vents
- Gloss Black side window surrounds
- Metal treadplates with R-Sport branding
- Bi-function Xenon headlights with LED 'J' Blade Daytime Running Lights
- Headlight powerwash
- Taurus Leather and Technical Mesh Sport seats
- Interior mood lighting
- Front fog lights



S

KEY FEATURES (IN ADDITION TO R-SPORT)

- 20" alloy wheels
- S Body kit including S front and rear bumpers, Body-coloured S door claddings with Satin Chrome finishers
- Metal treadplates with S branding
- LED headlights with LED 'J' Blade Daytime Running Lights
- Taurus Leather and Suedecloth Sport seats
- 10-way Electric front seats
- Meshed Aluminium trim finisher
- Bright Sport pedals
- Adaptive Dynamics
- Red brake calipers
- Satin Chrome gearshift paddles
- Suedecloth headlining - Jet

2 CHOOSE YOUR OPTIONS

 Configure your vehicle at jaguar.com

KEY STANDARD FEATURES

	PURE	PRESTIGE	PORTFOLIO	R-SPORT	S	DESCRIPTION
Stop/Start*	●	●	●	●	●	Refer to page 60
Hill Launch Assist	●	●	●	●	●	Prevents your F-PACE from rolling backwards when pulling away on an incline, helping you to make the perfect hill start every time
JaguarDrive Control with Eco, Dynamic, Normal, Rain Ice Snow Mode	●	●	●	●	●	Refer to page 26
Electric Power Assisted Steering (EPAS)	●	●	●	●	●	Refer to page 37
Electric Parking Brake with drive away release	●	●	●	●	●	Automatically releases the parking brake without the need for driver input as you press the accelerator to drive away
Emergency Brake Assist	●	●	●	●	●	Increases braking pressure in an emergency situation
Autonomous Emergency Braking	●	●	●	●	●	Refer to page 58
Hazard lights under heavy braking	●	●	●	●	●	
Airbags	●	●	●	●	●	Driver and front passenger with seat occupant detector for passenger, front side and full length side window curtain
Torque Vectoring	●	●	●	●	●	Refer to page 42
Dynamic Stability Control and Traction Control	●	●	●	●	●	Refer to page 45
Cruise Control and Speed Limiter	●	●	●	●	●	
Lane Departure Warning	●	●	●	●	●	Refer to page 58
Trailer Stability Assist	●	●	●	●	●	Intervenes when the system detects sway or potentially dangerous movement to bring the trailer back under control Refer to page 45
Electric front and rear windows with one-touch open/close and anti-trap	●	●	●	●	●	
Rain sensing windscreen wipers	●	●	●	●	●	
Two-zone climate control	●	●	●	●	●	
USB, Auxiliary socket and iPod® connectivity	●	●	●	●	●	Refer to page 51
Bluetooth® connectivity	●	●	●	●	●	Refer to page 51
Bluetooth® streaming	●	●	●	●	●	Refer to page 53
Push Button Start	●	●	●	●	●	

*Market dependent

● Standard ○ Option — Not available

Please consult your local Jaguar retailer for details.

Availability and fitment of features is market dependent.

For a complete list of optional features and packs refer to the F-PACE Specification and Price Guide or configure your vehicle at jaguar.com

KEY OPTIONAL FEATURES

		PURE	PRESTIGE	PORTFOLIO	R-SPORT	S	
TRANSMISSION AND DYNAMIC FEATURES		CODE					DESCRIPTION
Six-Speed manual transmission (only available on 2.0 litre 4 cylinder Turbocharged Diesel engines)	A40G	●	●	●	●	—	Refer to page 27
Eight-Speed automatic transmission with Jaguar Sequential Shift (includes gearshift paddles and All Surface Progress Control)	A40H	○	○	○	○	●	Refer to page 26
Configurable Dynamics (requires automatic transmission)	C35C	○	○	○	○	●	
Adaptive Dynamics	C35A	○	○	○	○	●	
Adaptive Cruise Control with Queue Assist (requires automatic transmission)	H41F	○	○	○	○	○	
Adaptive Surface Response (requires AWD, automatic transmission and Adaptive Dynamics)	B73F	○	○	○	○	○	Refer to page 41
350mm Brakes (standard on V6 engines)	G36B	○	○	○	○	●	

EXTERIOR FEATURES AND FINISHERS

EXTERIOR FEATURES AND TRIM							
Fixed Panoramic roof	F45A	○	○	○	○	○	
Sliding Panoramic roof	F45C	○	○	○	○	○	
Powered tailgate	B69B	○	○	○	○	○	
Gesture tailgate (requires Jaguar Smart Key System with Keyless Entry and Push Button Start)	B69C	○	○	○	○	○	
Chrome side window surround	D53C	—	●	●	○	○	
Gloss Black roof rails	B16D	○	○	○	○	○	
Satin Chrome roof rails	B16F	○	○	○	○	●	
R-Sport Body kit	—	—	—	—	●	—	Includes R-Sport front bumper, Body-coloured R-Sport door claddings with Satin Black finishers, Satin Chrome side power vents with R-Sport badge, R-Sport rear bumper
S Body kit	—	—	—	—	—	●	Includes S front bumper, Body-coloured S door claddings with Satin Chrome finishers, S rear bumper with Gloss Black finish and Satin Chrome diffuser
Delete Powertrain badging	B05H	○	○	○	○	—	

2 CHOOSE YOUR OPTIONS

 Configure your vehicle at jaguar.com

EXTERIOR FEATURES AND FINISHERS CONTINUED

		PURE	PRESTIGE	PORTFOLIO	R-SPORT	S	
GLASS AND EXTERIOR MIRRORS							DESCRIPTION
Infrared Reflective windscreen (front screen only)	D97B	○	○	○	○	○	Filters sunlight to reduce glare and prevent harmful UV rays from entering the cabin
Heated front windscreen with heated washer jets	D96A	○	○	○	○	○	
Privacy glass	H75A	○	○	○	○	○	
Heated door mirrors	B28J	●	●	●	●	●	
Heated door mirrors with Power Fold and Approach Lights	B28U	○	○	○	○	○	
Auto-Dimming Heated door mirrors with Power Fold and Approach Lights	B28P	○	○	○	○	○	Requires Auto-Dimming interior rear view mirror
HEADLIGHTS AND LIGHTING							
Halogen headlights with Daytime Running Lights	D90V	●	—	—	—	—	
Bi-function Xenon headlights with LED 'J' blade Daytime Running Lights	D90L	○	●	●	●	—	Includes Headlight Powerwash
LED headlights with LED 'J' blade Daytime Running Lights	D90T	○	○	○	○	●	Includes Auto High Beam Assist and Headlight Powerwash. Refer to page 12
Front fog lights	D01S	○	●	●	●	●	
TOWING							
Detachable tow bar	C05C	○	○	○	○	○	
Electrically deployable tow bar	C05B	○	○	○	○	○	
EXTERIOR COLOURS							(Please see pages 78-79 for full colour palette)
Solid paint	—	●	●	●	●	●	Refer to page 78
Metallic paint	—	○	○	○	○	○	Refer to pages 78-79
Premium paint	—	○	○	○	○	○	Refer to page 79
WHEELS							(Please see pages 80-81 to see the full range)
Tyre Repair System	C69A	●	●	●	●	●	
Space saver spare wheel	C40D	○	○	○	○	○	
Full size spare wheel (not available with loadspace storage rails)	C40K	○	○	○	○	○	
Tyre Pressure Monitoring System (TPMS)	C42R	●	●	●	●	●	

● Standard ○ Option — Not available

Please consult your local Jaguar retailer for details.

For a complete list of optional features and packs refer to the F-PACE Specification and Price Guide or configure your vehicle at jaguar.com

SEATING AND VENEERS

		PURE	PRESTIGE	PORTFOLIO	R-SPORT	S	
SEATING	CODE						DESCRIPTION
Heated front seats	F53A	○	○	○	○	○	
Heated front and rear seats	F53B	—	○	○	○	○	
Climate front seats with Heated rear seats (requires Leather seats and 4-Way Electric lumbar adjust)	F53C	—	○	○	○	○	
8-Way Manual front seats	Z02J	●	●	—	●	—	
10-Way Electric front seats	Z02P	○	○	●	○	●	Includes electric adjustment of fore/aft, cushion height, cushion tilt, squab recline and manual headrest height
10-Way Electric front seats with Memory (requires Auto-Dimming door mirrors)	Z02Q	○	○	○	○	○	Includes electric adjustment of fore/aft, cushion height, electric cushion tilt, squab recline and manual headrest height. Memory adjust driver seats, mirror position & steering wheel (if power adjustable column fitted)
4-Way Electric lumbar adjust (only available with 8-Way or 10-Way seats)	F52A	—	○	○	○	○	
14-Way Electric Sport front seats with 4-Way Electric lumbar adjust	Z02R	—	—	—	○	○	Includes electric adjustment of fore/aft, cushion height, cushion tilt, cushion extension, squab recline, bolster. Manual headrest height adjustment.
14-Way Electric Sport front seats with 4-Way Electric lumbar adjust and Memory	Z02S	—	—	—	○	○	Includes electric adjustment of fore/aft, cushion height, cushion tilt, cushion extension, squab recline, bolster. Manual headrest height adjustment. Memory adjust driver seats, mirror position & steering wheel (if power adjustable column fitted)
14-Way Electric Luxury front seats with manual headrest height, 4-Way Electric lumbar adjust and Driver and Passenger Memory	Z02M	—	—	○	—	—	Includes electric adjustment of fore/aft, cushion height, cushion tilt, cushion extension, squab recline, bolster. Manual headrest height adjustment. Memory adjusts driver and passenger seats (not side bolsters and lumbar), mirror position and steering wheel (if power adjustable column fitted)
Perforated Taurus Leather Sport seats	B41T	—	—	—	○	○	S model includes S logo embossed on front headrest
Rear armrest with twin cupholders	H51A	—	●	●	●	●	
Electrically reclining rear seats	H49A	—	○	○	○	○	
Rear seat remote release levers	H40A	○	○	○	○	○	

VENEERS

Please see pages 94-95 for full range of veneers

HEADLINING AND INTERIOR FEATURES

HEADLINING						
Light Oyster headlining	HAMT	●	●	●	●	○
Jet headlining	HPDB	○	○	○	○	●
Suedecloth headlining	H01D	—	—	○	○	●

2 CHOOSE YOUR OPTIONS

 Configure your vehicle at jaguar.com

HEADING AND INTERIOR FEATURES CONTINUED

INTERIOR FEATURES	CODE	PURE	PRESTIGE	PORTFOLIO	R-SPORT	S	DESCRIPTION
Illuminated metal treadplates with Jaguar script and metal loadspace scuff plate	F28F	○	○	○	○	○	
Carpet mats	H69H	○	●	●	●	●	
Premium carpet mats	H69J	○	○	○	○	○	
Bright Sport pedals	G48S	—	—	—	—	●	
Heated steering wheel	F97A	○	○	○	○	○	
Electrically adjustable steering column (requires Driver or Driver and Passenger Memory seats)	D07J	○	○	○	○	○	
Auto-Dimming interior rear view mirror	B68B	○	○	○	○	○	
Timed Climate with Remote Control	H10F	○	○	○	○	○	
Four-Zone climate control (requires Air Quality Sensor and Cooled Glove Box. Not available with 8-Way Manual front seats)	C88G	—	○	○	○	○	
Air Quality Sensor and Lockable Cooled Glove Box	C89A, B23H	○	○	○	○	○	
Interior lighting	B65C	●	—	—	—	—	
Interior mood lighting	B65A	○	●	—	●	●	
Configurable interior mood lighting (with 10 colours)	B65B	—	○	●	○	○	
Smoker's Pack	A03B	○	○	○	○	○	
Twin front cupholders with cover (requires Eight-Speed automatic transmission with Jaguar Sequential Shift)	G71E	○	○	○	○	○	
2 additional Power sockets	D72B	○	●	●	●	●	
Loadspace safety partition net	C02B	○	●	●	●	●	
Metal loadspace scuff plate	F31A	○	○	○	○	○	
Loadspace storage rails (not available with Full size spare wheel)	H52C	○	○	●	●	●	

● Standard ○ Option — Not available

Please consult your local Jaguar retailer for details.

For a complete list of optional features and packs refer to the F-PACE Specification and Price Guide or configure your vehicle at jaguar.com

HEADLINING AND INTERIOR FEATURES CONTINUED

		PURE	PRESTIGE	PORTFOLIO	R-SPORT	S	
INTERIOR FEATURES CONTINUED							DESCRIPTION
	CODE						
Rear Parking Aid	C11A	●	●	●	●	●	
Front Parking Aid (requires Rear Parking Aid)	C13A	○	○	○	○	○	
Rear View Camera (requires Front and Rear Parking Aid)	C14A	○	○	○	○	○	
Surround Camera System (requires Auto-Dimming mirrors and Front and Rear Parking Aid)	C14D	○	○	○	○	○	
360° Parking Aid (requires Front and Rear Parking Aid)	C17A	○	○	○	○	○	
Park Assist (requires Front and Rear Parking Aids, 360° Parking Aid)	C18B	○	○	○	○	○	
Garage door opener (HomeLink®) (requires Auto-Dimming Interior Rear View Mirror)	B20B	○	○	○	○	○	
Lane Keep Assist and Driver Condition Monitor (requires Auto-Dimming mirrors)	H72D	○	○	○	○	○	
Blind Spot Monitor and Reverse Traffic Detection (requires Auto-Dimming mirrors and Rear Parking Aid)	H71C	○	○	○	○	○	
Traffic Sign Recognition and Intelligent Speed Limiter (requires Navigation)	A41B	○	○	○	○	○	
Jaguar Smart Key System with Keyless Entry and Push Button Start	F04B	○	○	○	○	○	
Activity Key	F05D	○	○	○	○	○	

2 CHOOSE YOUR OPTIONS

 Configure your vehicle at jaguar.com

INFORMATION, COMMUNICATION AND ENTERTAINMENT

		PURE	PRESTIGE	PORTFOLIO	R-SPORT	S	
FEATURES ONLY AVAILABLE WITH INCONTROL TOUCH							DESCRIPTION
8 Inch Capacitive Touchscreen	G61C	●	●	●	●	●	Refer to page 51
Analogue dials with 5 Inch Full Colour TFT display	P50S	●	●	●	●	●	Refer to page 51
InControl SD Touch Navigation	G61C	○	○	○	○	○	Refer to page 52
Jaguar Sound System	B43T	●	●	●	●	●	Refer to page 52
Meridian Sound System	B44V	○	○	○	○	○	
InControl Apps	H57A	○	○	○	○	○	
InControl Connect Pack	Z77J	○	○	○	○	○	Consists of WiFi Hotspot, InControl Apps and InControl Remote Premium
FEATURES ONLY AVAILABLE WITH OPTIONAL INCONTROL TOUCH PRO							(Please see page 55 for more information)
InControl Touch Pro Navigation with 10.2 Inch Touchscreen, 12.3 Inch HD Virtual Instrument Display and Meridian Digital Sound System (380w)	Z59X	○	○	○	○	○	Refer to page 55
InControl Touch Pro Navigation with 10.2 Inch Touchscreen, 12.3 Inch HD Virtual Instrument Display and Meridian Digital Surround Sound System (825w)	Z59Y	○	○	○	○	○	Refer to page 55
InControl Connect Pro Pack	Z77A	○	○	○	○	○	Consists of InControl Pro Services, InControl Apps and InControl Remote Premium
InControl Apps	H57A	○	○	○	○	○	Consists of InControl Pro Services, InControl Apps and InControl Remote Premium
Digital TV	G52G	○	○	○	○	○	
FEATURES ONLY AVAILABLE WITH INCONTROL TOUCH AND INCONTROL TOUCH PRO							
InControl Protect	D45D	○	○	○	○	○	Refer to page 51
InControl Secure	D44A	○	○	○	○	○	Refer to page 51
Digital Audio Broadcast (DAB) Radio	B51A	○	○	○	○	○	

● Standard ○ Option — Not available

Please consult your local Jaguar retailer for details.

For a complete list of optional features and packs refer to the F-PACE Specification and Price Guide or configure your vehicle at jaguar.com

OPTION PACKS

OPTION PACKS	CODE	PURE	PRESTIGE	PORTFOLIO	R-SPORT	S	DESCRIPTION
Black Pack	—	○	○	○	○	○	Changes exterior finishers to Gloss Black. Black Pack exterior differences vary by model
Cold Climate Pack	Z88D	—	○	○	○	○	Consists of Heated front windscreen with heated washer jets, Heated steering wheel and Heated front and rear seats (heated front only on Pure)
Adaptive Dynamics Pack	Z07A	○	○	○	○	—	Consists of Adaptive Dynamics and Adaptive Surface Response (only available with Automatic transmission)
Head-Up Display Pack	Z13A	○	○	○	○	○	Consists of Infrared Reflective windscreen and Head Up display
Memory Pack for 10-Way seats	Z16X	○	○	○	○	○	Consists of 10-Way Electric front seats with manual headrest height and Driver Memory, Auto-Dimming interior rear view mirror, Auto-Dimming Heated door mirrors with Power Fold and Approach Lights and Electrically adjustable steering column
Memory Pack for 14-Way Sport seats	Z16Y	—	—	—	○	○	Consists of 14-Way Electric Sport front seats with 4-Way Electric lumbar adjust and Driver Memory, Auto-Dimming interior rear view mirror, Auto-Dimming Heated door mirrors with Power Fold and Approach Lights and Electrically adjustable steering column
Memory Pack for 14-Way Luxury seats	Z16W	—	—	○	—	—	Consists of 14-Way Electric Luxury front seats with manual headrest height, 4-Way Electric lumbar adjust and Driver and Passenger Memory, Auto-Dimming interior rear view mirror, Auto-Dimming Heated door mirrors with Power Fold and Approach Lights and Electrically adjustable steering column
Rear Seat Comfort Pack	Z12C	—	○	○	○	○	Consists of Heated front and rear seats, Cooled glovebox, Air Quality Sensor, Electrically reclining rear seats and 4-zone climate control
Practicality Pack	Z87A	○	○	○	○	○	Consists of Rear seat remote release levers, Gesture Tailgate, Loadspace safety partition net, Lockable cooled glovebox, Air Quality Sensor, Jaguar Smart Key System with Keyless Entry and Push Button Start
Luxury Pack	Z05C	○	○	○	○	○	Consists of Twin front cupholders with cover, Configurable interior mood lighting, Premium carpet mats, Illuminated metal treadplates with Jaguar script and metal loadspace scuff plate and Suedecloth headlining (only available with Automatic transmission)
Business Pack	Z04A	○	○	○	○	○	Consists of Front Parking Aid, Traffic Sign Recognition and Intelligent Speed Limiter, Rear View Camera, InControl Touch Navigation
Premium Business Pack	Z04B	○	○	○	○	○	Consists of Front Parking Aid, Traffic Sign Recognition with Intelligent Speed Limiter, Rear View Camera, InControl Touch Pro Navigation, 12.3 Inch HD virtual Instrument Display, Meridian Digital Sound System
Advanced Parking Assist Pack	Z68N	○	○	○	○	○	Consists of Front and Rear parking aids, Rear View Camera, 360° Parking Aid and Park Assist
Advanced Parking Assist Pack with Surround Camera	Z68Y	○	○	○	○	○	Consists of Front and Rear Parking Aids, Surround Camera System, 360° Parking Aid and Park Assist (requires Auto-Dimming door mirrors)

3 CHOOSE YOUR COLOUR

 [Configure your vehicle at jaguar.com](https://www.jaguar.com)

SOLID

Polaris White

Ebony Black

METALLIC

Glacier White

Ultimate Black

Ammonite Grey

Dark Sapphire Blue

British Racing Green

Quartzite

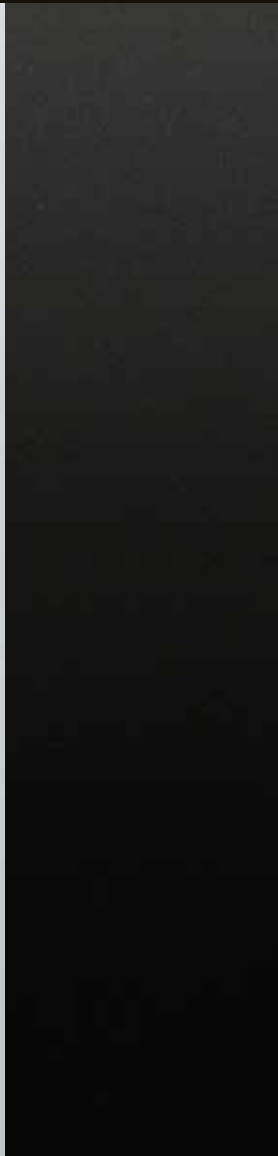
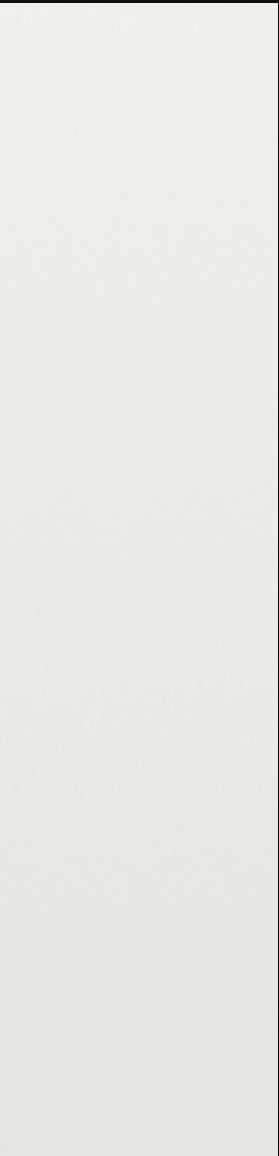

*Available Summer 2016

PREMIUM PALETTE

Italian Racing Red

Odyssey Red

Rhodium Silver

Tempest Grey

Gallium Silver*

Storm Grey

Ingot

Cosmic Black*



4 CHOOSE YOUR WHEELS

 Configure your vehicle at jaguar.com



18" LIGHTWEIGHT
15 SPOKE



18" AERO
10 SPOKE



18" VORTEX
10 SPOKE



19" FAN
5 SPOKE



19" FAN
5 SPOKE

ALLOY WHEEL FINISH	Silver	Silver	Silver	Silver	Gloss Black
ALLOY WHEEL/SIZE	7.5J x 18"	7.5J x 18"	7.5J x 18"	8.5J x 19"	8.5J x 19"
TYRE SIZE	255/60 R18	235/65 R18	255/60 R18	255/55 R19	255/55 R19
CODE	C54S	C54Q	C54R	C54U	C55R
Pure	●	○	○	○	○
Prestige	●	○	○	○	○
Portfolio	○	○	●	○	○
R-Sport	—	—	—	○	○
S	○	—	○	○	○



19" RAZOR
7 TWIN-SPOKE



19" BIONIC
5 TWIN-SPOKE



20" MATRIX
10 TWIN-SPOKE



20" VENOM
5 TWIN-SPOKE



20" VENOM
5 TWIN-SPOKE

ALLOY WHEEL FINISH	Silver	Grey and Diamond Turned	Silver	Gloss Black	Grey and Diamond Turned
ALLOY WHEEL/SIZE	8.5J x 19"	8.5J x 19"	8.5J x 20"	8.5J x 20"	8.5J x 20"
TYRE SIZE	255/55 R19	255/55 R19	255/50 R20	255/50 R20	255/50 R20
CODE	C54T	C54V	C54G	C54J	C54H
Pure	○	○	○	○	○
Prestige	○	○	○	○	○
Portfolio	○	○	○	○	○
R-Sport	○	●	○	○	○
S	○	○	○	○	○

● Standard ○ Option — Not Applicable

Standard and optional features may differ depending on market availability.



20" TEMPLAR
5 TWIN-SPOKE



20" BLADE
5 SPOKE



20" BLADE
5 SPOKE



22" DOUBLE HELIX
15 SPOKE

ALLOY WHEEL FINISH	Silver	Grey and Diamond Turned	Gloss Black	Silver finish and contrast inserts
ALLOY WHEEL/SIZE	8.5J x 20"	8.5J x 20"	8.5J x 20"	9.0J x 22"
TYRE SIZE	255/50 R20	255/50 R20	255/50 R20	265/40 R22
CODE	C54F	C54X	C54Y	C54K

Pure	<input type="radio"/>	<input type="radio"/>	<input type="radio"/>	<input type="radio"/>
Prestige	<input type="radio"/>	<input type="radio"/>	<input type="radio"/>	<input type="radio"/>
Portfolio	<input type="radio"/>	<input type="radio"/>	<input type="radio"/>	<input type="radio"/>
R-Sport	<input type="radio"/>	<input type="radio"/>	<input type="radio"/>	<input type="radio"/>
S	<input type="radio"/>	<input checked="" type="radio"/>	<input type="radio"/>	<input type="radio"/>



22" DOUBLE HELIX
15 SPOKE



22" TURBINE
9 SPOKE



22" TURBINE
9 SPOKE

ALLOY WHEEL FINISH	Black finish and contrast finish inserts	Grey and Diamond Turned	Chrome
ALLOY WHEEL/SIZE	9.0J x 22"	9.0J x 22"	9.0J x 22"
TYRE SIZE	265/40 R22	265/40 R22	265/40 R22
CODE	C54L	C54M	C54N

Pure	<input type="radio"/>	<input type="radio"/>	<input type="radio"/>
Prestige	<input type="radio"/>	<input type="radio"/>	<input type="radio"/>
Portfolio	<input type="radio"/>	<input type="radio"/>	<input type="radio"/>
R-Sport	<input type="radio"/>	<input type="radio"/>	<input type="radio"/>
S	<input type="radio"/>	<input type="radio"/>	<input type="radio"/>

5 CHOOSE YOUR INTERIOR

 Configure your vehicle at jaguar.com

PURE						
	SEAT WITH TONAL STITCH	FINISHER	HEADLINING MORZINE	UPPER FACIA WITH NO STITCH	CARPET	INTERIOR TRIM AND OPTION CODES
Standard						
Premium cloth seats	Jet with Jet	Gloss Black	Light Oyster or Jet**	Jet	Jet	TR44
PRESTIGE						
	SEAT WITH CONTRAST STITCH	FINISHER	HEADLINING MORZINE	UPPER FACIA WITH NO STITCH	CARPET	INTERIOR TRIM AND OPTION CODES
Standard						
Taurus Leather seats	Jet with Siena Tan	Gloss Black	Light Oyster or Jet**	Jet	Jet	TR46
	Latte with Espresso	Gloss Black	Light Oyster or Jet**	Espresso	Espresso	TR48
	Light Oyster with Pistachio	Gloss Black	Light Oyster or Jet**	Jet	Jet	TR47
PORTFOLIO						
	SEAT WITH TONAL STITCH	FINISHER	HEADLINING MORZINE*	UPPER FACIA WITH TONAL STITCH	CARPET	INTERIOR TRIM AND OPTION CODES
Standard						
Perforated Windsor Leather seats	Jet with Jet	Gloss Figured Ebony	Light Oyster or Jet**	Jet with Jet	Jet	TR58
	Espresso with Espresso	Gloss Figured Ebony	Light Oyster or Jet**	Espresso with Espresso	Espresso	TR61
	Siena Tan with Siena Tan	Gloss Figured Ebony	Light Oyster or Jet**	Jet with Jet	Jet	TR62
	Latte with Latte	Gloss Figured Ebony	Light Oyster or Jet**	Espresso with Espresso	Espresso	TR59
	Light Oyster with Light Oyster	Gloss Figured Ebony	Light Oyster or Jet**	Oyster with Oyster	Oyster	TR60

*Suede cloth headlining available as an option
 **Jet headlining available as an option
 †Light Oyster headlining available as an option
 **Morzine headlining available as an option

R-SPORT						
	SEAT WITH CONTRAST STITCH	FINISHER	HEADLINING MORZINE*	UPPER FACIA WITH NO STITCH	CARPET	INTERIOR TRIM AND OPTION CODES
Standard						
Sports Taurus Leather seats with technical mesh inserts	Jet/Jet with Light Oyster	Gloss Black	Light Oyster or Jet**	Jet	Jet	TR49
	SEAT WITH CONTRAST STITCH	FINISHER	HEADLINING MORZINE*	UPPER FACIA WITH CONTRAST STITCH	CARPET	INTERIOR TRIM AND OPTION CODES
Optional						
Perforated Taurus Leather Sport seats	Jet/Jet with Light Oyster	Gloss Black	Light Oyster or Jet**	Jet with Light Oyster	Jet	TR49 +B41T (leather upgrade)
	Jet/Red with Red	Gloss Black	Light Oyster or Jet**	Jet with Red	Jet	TR50
	Jet/Light Oyster with Light Oyster	Gloss Black	Light Oyster or Jet**	Jet with Light Oyster	Jet	TR51
	Oyster/Oyster with Lime	Gloss Black	Light Oyster or Jet**	Oyster with Lime	Oyster	TR52
S						
	SEAT WITH CONTRAST STITCH	FINISHER	HEADLINING SUEDECLOTH**	UPPER FACIA WITH NO STITCH	CARPET	INTERIOR TRIM AND OPTION CODES
Standard						
Sports Taurus Leather seats with Suedecloth inserts	Jet/Jet with Light Oyster	Meshed Aluminium	Jet or Light Oyster†	Jet	Jet	TR53
	SEAT WITH CONTRAST STITCH	FINISHER	HEADLINING SUEDECLOTH**	UPPER FACIA WITH CONTRAST STITCH	CARPET	INTERIOR TRIM AND OPTION CODES
Optional						
Perforated Taurus Leather Sport seats	Jet/Jet with Light Oyster	Meshed Aluminium	Jet or Light Oyster**	Jet with Light Oyster	Jet	TR53+B41T (leather upgrade)
	Red/Jet with Jet	Meshed Aluminium	Jet or Light Oyster**	Jet with Red	Jet	TR54
	Brogue/Brogue with Light Oyster	Meshed Aluminium	Jet or Light Oyster**	Jet with Light Oyster	Jet	TR56

5 CHOOSE YOUR INTERIOR

⚙️ Configure your vehicle at [jaguar.com](https://www.jaguar.com)

Interior shown: Jet cloth seats with Gloss Black finisher, Light Oyster headlining and Jet facia.



PURE

INTERIOR COLOUR COMBINATIONS

STANDARD

1

SEAT WITH TONAL STITCH



Jet

2

FINISHER



Gloss Black

3

HEADLINING MORZINE



Light Oyster or Jet*

4

UPPER FACIA
WITH NO STITCH



Jet

5

CARPET



Jet

*Jet headlining available as an option.

5 CHOOSE YOUR INTERIOR

⚙️ Configure your vehicle at [jaguar.com](https://www.jaguar.com)















Interior shown: Latte Taurus leather seats with Espresso contrast stitch, Gloss Black finisher with Light Oyster headlining and Espresso facia.



PRESTIGE

INTERIOR COLOUR COMBINATIONS

STANDARD

1	2	3	4	5
SEAT WITH CONTRAST STITCH  Jet with Siena Tan	FINISHER  Gloss Black	HEADLINING MORZINE  Light Oyster or Jet*	UPPER FACIA WITH NO STITCH  Jet	CARPET  Jet
 Latte with Espresso	 Gloss Black	 Light Oyster or Jet*	 Espresso	 Espresso
 Light Oyster with Pistachio	 Gloss Black	 Light Oyster or Jet*	 Jet	 Jet

FINISHER OPTIONS

Satin Fine Line Wood, Satin Ash Burr, Satin Grey Ash, Satin Grey Figured Ebony, Gloss Figured Ebony, Etched Aluminium or Meshed Aluminium

*Jet headlining available as an option.

5 CHOOSE YOUR INTERIOR

⚙️ Configure your vehicle at jaguar.com













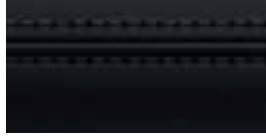









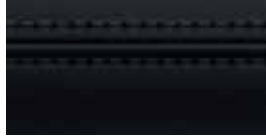

Interior shown: Siena Tan Windsor leather seats with Siena Tan tonal stitch, Gloss Figured Ebony finisher with Light Oyster headlining and Jet facia.



PORTFOLIO

INTERIOR COLOUR COMBINATIONS

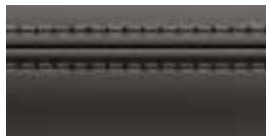
STANDARD

1	2	3	4	5
SEAT WITH TONAL STITCH	FINISHER	HEADLINING MORZINE*	UPPER FACIA WITH TONAL STITCH	CARPET
				
Jet with Jet	Gloss Figured Ebony	Light Oyster or Jet**	Jet with Jet	Jet
				
Espresso with Espresso	Gloss Figured Ebony	Light Oyster or Jet**	Espresso with Espresso	Espresso
				
Siena Tan with Siena Tan	Gloss Figured Ebony	Light Oyster or Jet**	Jet with Jet	Jet
				
Latte with Latte	Gloss Figured Ebony	Light Oyster or Jet**	Espresso with Espresso	Espresso
				
Light Oyster with Light Oyster	Gloss Figured Ebony	Light Oyster or Jet**	Oyster with Oyster	Oyster

FINISHER OPTIONS

Satin Fine Line Wood, Satin Ash Burr, Satin Ash Grey, Satin Grey Figured Ebony, Gloss Black, Etched Aluminium or Meshed Aluminium

*Suedecloth headlining available as an option.
 **Jet headlining available as an option.

5 CHOOSE YOUR INTERIOR

⚙️ Configure your vehicle at [jaguar.com](https://www.jaguar.com)

Interior shown: Jet and Red Taurus leather Sports seats with Red contrast stitch, Etched Aluminium finisher with Jet headlining and Jet facia.

















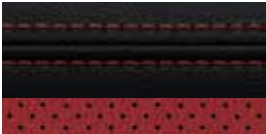



R-SPORT

INTERIOR COLOUR COMBINATIONS

STANDARD

①	②	③	④	⑤
SEAT WITH CONTRAST STITCH	FINISHER	HEADLINING MORZINE*	UPPER FACIA	CARPET
				
Jet/Jet with Light Oyster	Gloss Black	Light Oyster or Jet**	Jet	Jet

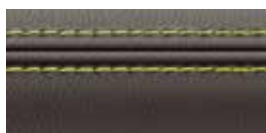
OPTIONAL

				
Jet/Jet with Light Oyster	Gloss Black	Light Oyster or Jet**	Jet with Light Oyster	Jet
				
Jet/Red with Red	Gloss Black	Light Oyster or Jet**	Jet with Red	Jet
				
Jet/Light Oyster with Light Oyster	Gloss Black	Light Oyster or Jet**	Jet with Light Oyster	Jet
				
Oyster/Oyster with Lime	Gloss Black	Light Oyster or Jet**	Oyster with Lime	Oyster

FINISHER OPTIONS

Satin Fine Line Wood, Satin Ash Burr, Satin Grey Ash, Satin Grey Figured Ebony, Gloss Figured Ebony, Etched Aluminium or Meshed Aluminium

*Suedecloth headlining available as an option.
 **Jet headlining available as an option.

5 CHOOSE YOUR INTERIOR

⚙️ Configure your vehicle at jaguar.com

Interior shown: Brogue Taurus leather Sports seats with Light Oyster contrast stitch, Meshed Aluminium finisher with Jet headlining and Jet fascia.

















S

INTERIOR COLOUR COMBINATIONS

STANDARD

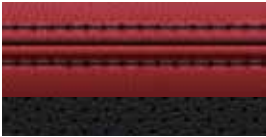
①	②	③	④	⑤
SEAT WITH CONTRAST STITCH	FINISHER	HEADLINING SUEDECLOTH*	UPPER FACIA	CARPET
				
Jet/Jet with Light Oyster	Meshed Aluminium	Jet or Light Oyster**	Jet	Jet

OPTIONAL

				
Jet/Jet with Light Oyster	Meshed Aluminium	Jet or Light Oyster**	Jet with Light Oyster	Jet
				
Brogue/Brogue with Light Oyster	Meshed Aluminium	Jet or Light Oyster**	Jet with Light Oyster	Jet
				
Red/Jet with Jet	Meshed Aluminium	Jet or Light Oyster**	Jet with Red	Jet

FINISHER OPTIONS

Satin Fine Line Wood, Satin Ash Burr, Satin Grey Ash, Satin Grey Figured Ebony, Gloss Figured Ebony, Etched Aluminium or Gloss Black

*Morzine headlining available as an option.

**Light Oyster headlining available as an option.

5 CHOOSE YOUR INTERIOR

 Configure your vehicle at jaguar.com

Gloss Black finisher

Meshed Aluminium finisher

Etched Aluminium finisher

Gloss Figured Ebony veneer



Satin Grey Figured Ebony veneer



Satin Fine Line Wood veneer



Satin Ash Burr veneer



Satin Grey Ash veneer



6 CHOOSE YOUR JAGUAR ACCESSORIES

 To find out more about the full range of retailer fit Jaguar Accessories, please refer to your retailer or go to accessories.jaguar.com

*Fitting of Side Steps or Side Tubes may affect the off-road capability of the vehicle.

Deployable Side Steps



Fixed Side Steps



Tow Bar 2 Bike Carrier



Bright Side Tubes



Front Mud Flaps



Gloss Black Side Power Vent



Carbon Fibre Side Power Vent



Roof Cross Bars



Surfboard/Kayak/Sailboard Holder



Gloss Black Mirror Caps



Carbon Fibre Mirror Caps



Roof Sport Box



Ski/Snowboard Holder

6 CHOOSE YOUR JAGUAR ACCESSORIES

 To find out more about the full range of retailer fit Jaguar Accessories, please refer to your retailer or go to accessories.jaguar.com

Aluminium Paddle Shifters



Jet Luxury Carpet Mats



Sport Pedal Covers

Central Armrest Chiller/Warmer



iPad Holder



Flexible Luggage Retainer



Personalised Illuminated Treadplates



Headrest Mounted Coat Hanger



Flexible Luggage Compartment Liner



Metal Treadplates with Union Jack

TECHNICAL SPECIFICATIONS

 Configure your vehicle at jaguar.com

ENGINES		2.0 LITRE 4 CYLINDER TURBOCHARGED DIESEL	2.0 LITRE 4 CYLINDER AWD TURBOCHARGED DIESEL	2.0 LITRE 4 CYLINDER AWD TURBOCHARGED DIESEL
Capacity	cc	1,999	1,999	1,999
Maximum power	EEC-PS (kW)	180 (132)	180 (132)	180 (132)
@rev/min	rpm	4,000	4,000	4,000
Maximum torque	EEC-Nm (lb.ft.)	430 (318)	430 (318)	430 (318)
@rev/min	rpm	1,750-2,500	1,750-2,500	1,750-2,500
PERFORMANCE		MANUAL	MANUAL	AUTOMATIC
0-100 km/h	seconds	8.9	8.7	8.7
0-60 mph	seconds	8.5	8.2	8.2
Top speed	km/h (mph)	209 (130)*	208 (129)	208 (129)
FUEL CONSUMPTION ¹				
Urban	l/100km (mpg)	5.7 (49.6)	6.0 (47.1)	6.2 (45.6)
Extra Urban	l/100km (mpg)	4.5 (62.8)	4.7 (60.1)	4.7 (60.1)
Combined	l/100km (mpg)	4.9 (57.7)	5.2 (54.3)	5.3 (53.3)
CO ₂	g/km	129	134	139
Tank capacity (usable)	litres approx.	60	60	60
DIMENSIONS				
Overall length	mm	4,731	4,731	4,731
Overall width (inc. mirrors)	mm	2,175	2,175	2,175
Overall width (exc. mirrors)	mm	1,936	1,936	1,936
Overall height	mm	1,652	1,652	1,652
Wheelbase	mm	2,874	2,874	2,874
Front track	mm	1,641	1,641	1,641
Rear track	mm	1,654	1,654	1,654
Ground clearance	mm	213	213	213
Turning circle diameter (kerb to kerb)	metres	11.87	11.87	11.87
Boot volume	litres	650	650	650
WEIGHT ²				
Weight from	kg	1,665	1,767	1,775
Gross vehicle weight	kg	2,380	2,460	2,460
Towing Capacity	kg	2,000	2,000	2,400
ENGINE AVAILABILITY				
Pure		●	●	●
Prestige		●	●	●
Portfolio		●	●	●
R-Sport		●	●	●
S		—	—	—

— Not Available ● Available

ENGINES		3.0 LITRE V6 AWD TURBOCHARGED DIESEL	3.0 LITRE V6 AWD SUPERCHARGED PETROL	3.0 LITRE V6 AWD SUPERCHARGED PETROL
Capacity	cc	2,993	2,995	2,995
Maximum power	EEC-PS (kW)	300 (221)	340 (250)	380 (280)
@rev/min	rpm	4,000	6,500	6,500
Maximum torque	EEC-Nm (lb.ft.)	700 (516)	450 (332)	450 (332)
@rev/min	rpm	2,000	4,500	4,500
PERFORMANCE		AUTOMATIC	AUTOMATIC	AUTOMATIC
0-100 km/h	seconds	6.2	5.8	5.5
0-60 mph	seconds	5.8	5.4	5.1
Top speed	km/h (mph)	241 (150)	250 (155)**	250 (155)**
FUEL CONSUMPTION ¹				
Urban	l/100km (mpg)	6.9 (40.9)	12.2 (23.2)	12.2 (23.2)
Extra Urban	l/100km (mpg)	5.6 (50.4)	7.1 (39.8)	7.1 (39.8)
Combined	l/100km (mpg)	6.0 (47.1)	8.9 (31.7)	8.9 (31.7)
CO ₂	g/km	159	209	209
Tank capacity (usable)	litres approx.	66	63	63
DIMENSIONS				
Overall length	mm	4,731	4,731	4,731
Overall width (inc. mirrors)	mm	2,175	2,175	2,175
Overall width (exc. mirrors)	mm	1,936	1,936	1,936
Overall height	mm	1,652	1,652	1,652
Wheelbase	mm	2,874	2,874	2,874
Front track	mm	1,641	1,641	1,641
Rear track	mm	1,654	1,654	1,654
Ground clearance	mm	213	213	213
Turning circle diameter (kerb to kerb)	metres	11.87	11.87	11.87
Boot volume	litres	650	650	650
WEIGHT ²				
Weight from	kg	1,884	1,820	1,861
Gross vehicle weight	kg	2,570	2,500	2,500
Towing Capacity	kg	2,400	2,400	2,400
ENGINE AVAILABILITY				
Pure		●	●	—
Prestige		●	●	—
Portfolio		●	●	—
R-Sport		●	●	—
S		●	—	●

*On Pure models top speed is restricted to 195km/h when fitted with 18" alloy wheels and 235/65 R18 tyres. **Limited top speed

¹The figures provided are as a result of official manufacturer's tests in accordance with EU legislation. A vehicle's actual fuel consumption may differ from that achieved in such tests and these figures are for comparative purposes only

²Weights reflect vehicles to standard specifications. Optional extras increase weight

DIMENSIONS

Overall width (inc. mirrors) 2,175mm

Overall width (exc. mirrors) 1,936mm

Boot volume 650* Litres

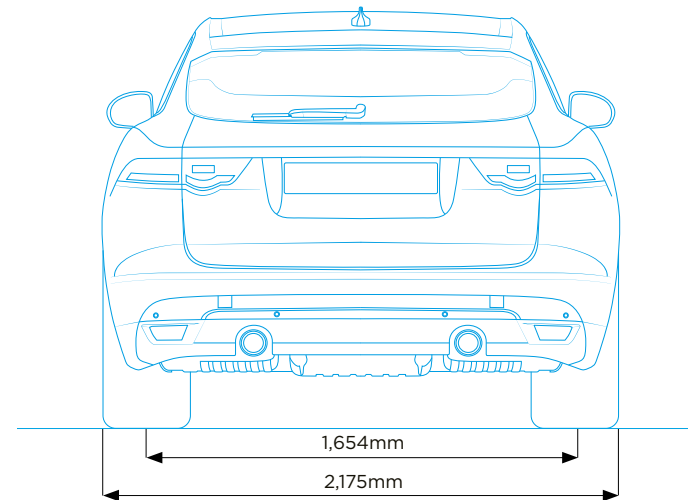
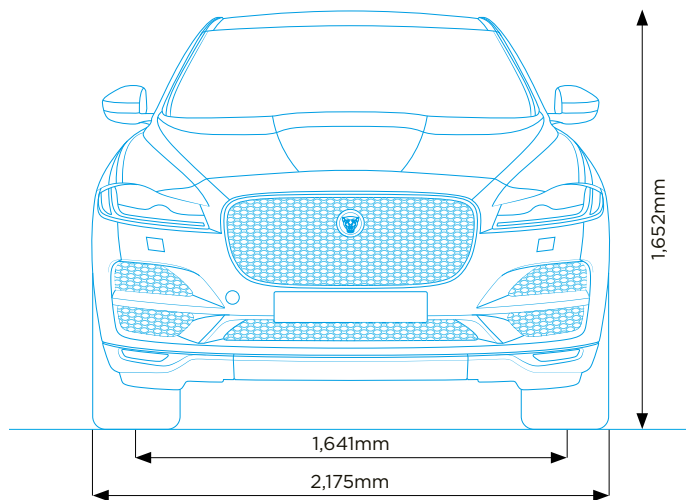

Turning Circle
Kerb-to-kerb 11.87 metres
Turns lock to lock 2.5

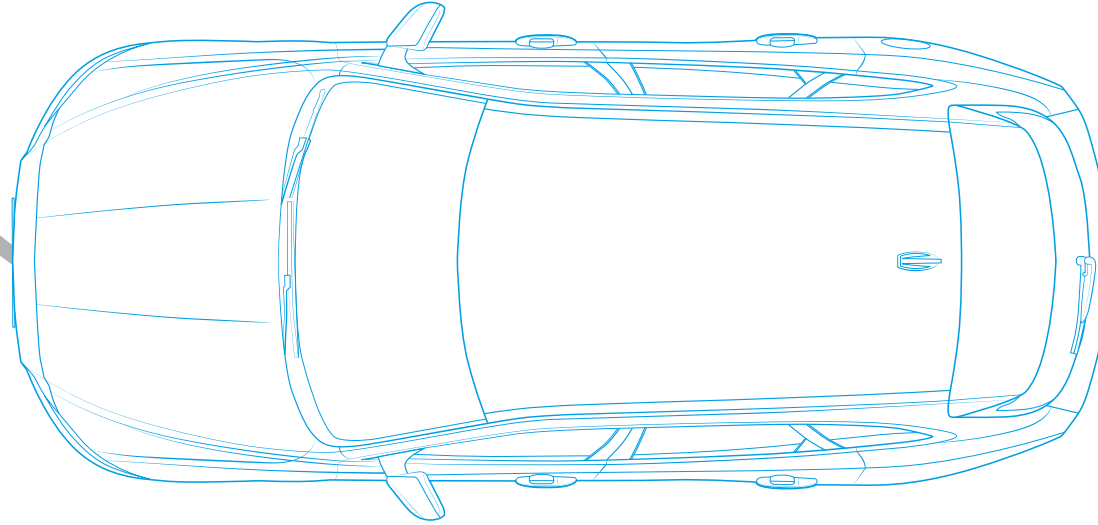

Headroom
Maximum front headroom
1,007mm**
Rear headroom
977mm**

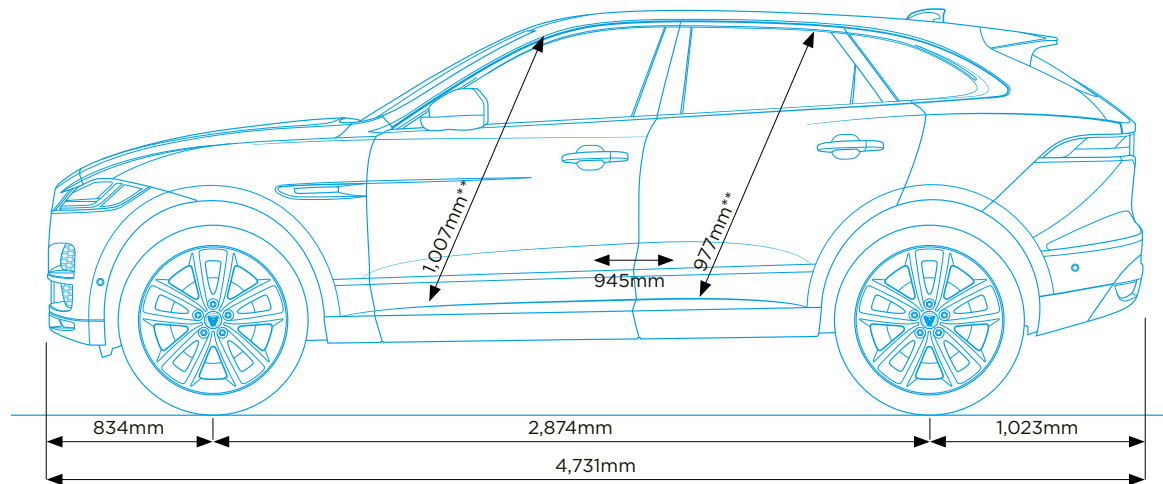

*When fitted with Tyre Repair System **Maximum headroom with fixed metal roof
Dimensions in millimetres. Dimensions were measured with vehicle at unladen weight. Luggage compartment volume in litres: 650*/1740*
Vehicle shown includes options (market dependent).



JAGUAR EXPERIENCE

There's no better way to get to know F-PACE and Jaguar than by taking a drive*. Jaguar Experience offers a range of unique opportunities to really find out what it feels like to get the most out of a Jaguar. Our track experiences allow you to push yourself, F-PACE and other cars from the incredible Jaguar range to the limit. Jaguar Experience also offers the opportunity to see a Jaguar brought to life during a tour of one of our UK manufacturing facilities. Find out more by visiting jaguar.com/experience

*Available from market start date of sales. Please check with your local Jaguar retailer for availability.



Follow us on:



Facebook.com



Instagram.com



Twitter.com



Youtube.com

THE WORLD OF JAGUAR

Choose an F-PACE and you're joining the exciting World of Jaguar. It makes owning and driving carefree and easy, as well as providing a range of exclusive services and lifestyle products.



JAGUAR CARE*

F-PACE is offered with a new unlimited mileage, three year warranty and three years' standard servicing programme. We call this programme Jaguar Care. It makes F-PACE's overall cost of ownership one of the lowest in its class.



SERVICING

F-PACE has been designed to keep servicing costs to a minimum - for example, the new Ingenium diesel engines can achieve an incredible 34,000km or 2 years[†] between services due to intelligent design and advanced oil technology.

GENUINE PARTS

Jaguar Genuine Parts are designed, tested and manufactured to our uncompromising standards for quality, fit and durability. Each part is engineered specifically for your F-PACE to contribute to optimum performance and to help maximise its lifespan.



FLEET & BUSINESS

Jaguar is dedicated to being the premium manufacturer of choice for fleets and businesses by providing a highly attractive car range and exemplary customer service. Jaguars are dynamic and distinctive cars that help companies express the unique character and personality of their business. We are committed to providing totally customer-focused aftersales services, which keeps every Jaguar car on the move and in top condition, ensuring that they perform to the highest standard and in the most cost-efficient way for businesses. Visit jaguar.com/fleet-and-business for more information.

*Selected European Markets only.



JAGUAR FINANCIAL SERVICES

Effortless performance and style come as standard with every Jaguar. Jaguar Financial Services makes buying one just as simple and rewarding. New or used, for personal or business use, we have an option that puts you in complete control. Please speak to your local Jaguar retailer to find out more.



JAGUAR ASSISTANCE

Jaguar Assistance provides assistance in motoring emergencies, from immobilisation due to breakdown or accident to minor problems such as punctures. You can rely on our roadside assistance, whatever the situation, wherever you happen to be.

INSURANCE

F-PACE's key components are easily accessible for time-efficient service and repair costs. With a focus on lower repair costs, F-PACE delivers competitive insurance group ratings**. To find out more about the compelling business case for F-PACE, please contact your local Jaguar retailer.



JAGUAR MAGAZINE

Jaguar Magazine is the official magazine of Jaguar Cars. It features the All-New Jaguar F-PACE, F-TYPE, XJ, XE and XF, and the worlds of luxury, style, design and travel.

JAGUAR COLLECTION

The latest range from the Jaguar Collection has been crafted with the same design execution and attention to detail that goes into all of our cars. This is evident in our clothing range, premium leather items and luxury travel goods. To celebrate Jaguar's heritage we also have a collection that honours past achievements and features race inspired gift items and apparel. To find out more, visit the online shop at www.jaguar.com/shop

** Manufacturer's estimate
*Market and driving style dependent.

GLOSSARY

A

ADAPTIVE LED HEADLIGHTS

Adaptive LED Headlights automatically adjust to follow steering inputs, casting light where needed. They will angle the beam when indicating, as well as working in conjunction with Automatic High Beam Assist to prevent your lights from dazzling oncoming traffic.

AUDIO EQUALISATION

Audio Equalisation lets you fine tune the sound of your car's audio system by giving you tone adjustment not covered by standard treble, mid-range, and bass controls.

C

Cd.

The Cd. value is the drag coefficient of the car. It gives an indication of the vehicle's aerodynamic qualities. The lower the value, the more aerodynamically efficient the vehicle's design.

D

DAMPERS/DAMPING

Dampers absorb forces acting on the suspension for greater ride comfort and control. Dampers are also known as shock absorbers.

DRAG COEFFICIENT

The drag coefficient measures how aerodynamic a car is. See definition of Cd.

DSP AMPLIFIER

Meridian's Digital Signal Processing (DSP) technology analyses a range of variables that may impact audio quality, then processes them using sophisticated algorithms and adapts the system's output accordingly. This enables a level of powerful, authentic performance impossible with a conventional sound system.

E

ECO MODE

Eco Mode encourages fuel efficient driving by reducing throttle sensitivity, selecting more economical engine mapping and, on manual vehicles, advising of gear shifts. It also reduces fuel consumption by reducing the energy demands placed on the engine by climate control and audio systems.

J

JAGUARDRIVE CONTROL

Interacts with the Dynamic Stability Control system, engine and transmission management systems to alter the characteristics of the engine mapping, gear shifts and brakes. It offers different modes designed to optimise the vehicle's response to particular driving conditions and styles.

'J' BLADE DAYTIME RUNNING LIGHTS

'J' Blade Daytime Running Lights are separate LED running lights, in a distinctive 'J' shape, built into the headlights. They emphasise Jaguar's striking on road style.

JAGUARDRIVE SELECTOR

The JaguarDrive Selector rises from the centre console on start up. It is a rotary shifter used with automatic transmissions that allows you to quickly shift between drive modes.

S

SUPERCHARGED PETROL

A petrol engine with a supercharger. A supercharger is a forced induction device mechanically driven by the engine. It offers higher power outputs and immediate, linear response at all engine speeds.

T

10.2 INCH MULTI-TOUCHSCREEN WITH MULTI-TOUCH GESTURES

The Multi-touch functionality of InControl Touch Pro's 10.2 inch Display allows the screen to recognise multiple points of contact. This provides direct control of the system's features in a more natural, intuitive way, enabling gestures such as pinch and zoom.

TURBOCHARGED DIESEL

Diesel engine with a turbocharger. A turbocharger is a forced induction device powered by exhaust gases. Turbocharging produces higher power outputs, lower emissions levels, and improved efficiency and refinement compared to similar capacity naturally aspirated engines.

X

XENON HEADLIGHTS

Bi-function Xenon headlights offer improved illumination and feature LED 'J' Blade Daytime Running Lights for a striking on road style.

